

SHARING STAGES  
WITH YOU



grau®

# SHARING STAGES WITH YOU



# Contenidos

## Contents

ES

01 — GRAU	04
04	Bienvenida
06	Educación colaborativa
10	Conciencia ecológica
12	Servicios
02 — AMBIENTES	16
18	Colaborativo
22	Infantil
26	Convencional
28	Biblioteca
30	Comedor
03 — PRODUCTOS	32
32	Pupitres
50	Mesas
60	Sillas
74	Almacenaje
86	Infantil
04 — ESPACIOS	94
05 — GENERAL	104
106	Técnico
108	Overview

EN

01 — GRAU	04
04	Welcome
06	Collaborative learning
10	Environmental awareness
12	Services
02 — ENVIRONMENTS	16
18	Collaborative
22	Infants
26	Conventional
28	Library
30	Dining hall
03 — PRODUCTS	32
32	Desks
50	Tables
60	Chairs
74	Storage
86	Infants
04 — SPACES	94
05 — GENERAL	104
106	Specifications
108	Overview

Bienvenidos  
a Grau

*Welcome  
to Grau*



↑ SANTA EUGÈNIA DE BERGA (ESPAÑA / SPAIN)

### ¿Conoces Grau? — *Have you heard of Grau?*

ES

Desde 1955, diseñamos y fabricamos mobiliario para espacios educativos. Una larga experiencia en el sector y la constante comunicación con profesionales del sector de la enseñanza nos permite diseñar y crear el espacio idóneo que cumpla el principal objetivo del aula: enseñar y aprender.

La evolución de los sistemas educativos nos permite adaptarnos y evolucionar según las necesidades de cada etapa de aprendizaje. El mobiliario de Grau está pensado y diseñado para crecer con el alumno.

Ubicados en Santa Eugènia de Berga (España) y con un cualificado equipo humano, en Grau nos apasiona lo que hacemos y estamos encantados de presentaros la nueva línea de productos Grau, con nuevas formas y colores, debidamente estudiada para que el entorno de aprendizaje sea lo más acogedor posible para el alumno.



↑ PROCESOS DE FABRICACIÓN / MANUFACTURING PROCESS



EN

We have been designing and building furniture for educational settings since 1955. Our long experience in the industry and constant dialogue with education professionals enables us to design and create a space that allows the classroom to fulfil its primary purpose: teaching and learning.

Systems of education allow us to develop and adapt to the needs of each stage of learning. Grau's furniture is meant to grow with the student.

Based in Santa Eugènia de Berga near Barcelona in Spain, Grau and its expert staff are passionate about what we do and we are delighted to have this opportunity to show you our new Grau product line with its new shapes and colours, all carefully thought through to ensure that the learning environment is as welcoming as possible for students.



↑ ESPACIOS COLABORATIVOS / COLLABORATIVE SPACES

## Educación colaborativa — *Collaborative learning*

### ES

La mejora de los resultados académicos se ha convertido en un reto prioritario para contribuir al desarrollo de la sociedad actual. Este reto nos lleva a un objetivo fundamental: conseguir que el alumno pueda extraer su máximo rendimiento dentro de su proceso de aprendizaje.

En los últimos años, se han realizado importantes estudios en los que se revela que son muchos los factores del entorno físico que influyen en la atención,

la motivación y, en consecuencia, en el aprendizaje de los alumnos, de modo que la disposición tradicional del aula (donde el alumno tiene una actitud más pasiva y por lo tanto una capacidad de atención y de concentración limitada) se transformará en un espacio de trabajo colaborativo en el que «los alumnos toman el protagonismo de forma activa, incentivando la atención, la motivación y la aportación de sus inteligencias múltiples». (Howard Gardner, 2005)

### EN

The challenge of improving educational attainment has become a priority to drive the development of today's societies. This challenge leads us to a fundamental goal: to ensure that each student can reach the highest level of which he or she is capable within the learning process.

In recent years, significant research has shown that there are many aspects of the physical environment that affect attention and motivation and that therefore affect students learning. This means that the traditional classroom layout (where the student is passive and

therefore with low levels of attention and concentration) has to change to become a learning space where «students actively take the lead, incentivising attention, motivation and the contribution of their multiple intelligences». (Howard Gardner, 2005)



Un mismo espacio, diferentes posibilidades — *Same space, different possibilities*



↑ MUEBLES VERSÁTILES / VERSATILE FURNITURE



ES

Diseñar los espacios de aprendizaje en esta nueva dirección en la que un mismo espacio puede tener distintas finalidades nos ayudará a obtener una mejor experiencia educativa, tanto para el profesor como para el alumno. Tal y como decía ya en los años 50 el influyente maestro y pedagogo Loris Malaguzzi, «La escuela concebida como lugar de aprendizaje supone pensar en los espacios y materiales del aula como el tercer ecuador». Y es en este sentido que el mobiliario de las aulas ha hecho su aportación, incorporando nuevos diseños y funcionalidades que se adaptan plenamente al nuevo método de aprendizaje colaborativo y versátil.

EN

Designing learning spaces in this new spirit where a single space can have many different uses can help us to improve the educational experience, both for the teacher and for the student. Loris Malaguzzi, the leading educational theorist was saying the same thing 50 years ago: «School conceived of as a place of learning requires us to think of the space and materials of the classroom as the third educator». And that is the sense in which classroom furniture has contributed, bringing new designs and functionalities that are fully adapted to the new, versatile method of collaborative learning.



## Conciencia ecológica — *Environmental awareness*

ES

En Grau tenemos conciencia y compromiso con la sostenibilidad y el comercio justo. Nuestros productos están fabricados en Santa Eugènia de Berga (España), con materiales de proximidad para minimizar el impacto medioambiental.

Los artículos de Grau están diseñados y fabricados para una larga durabilidad, reduciendo así la extracción de materias primas de la Tierra. Durante su proceso de fabricación, desarrollamos y utilizamos diferentes métodos y tecnologías para reducir los efectos de la contaminación, apostando por el uso de energías renovables y el reciclaje.

EN

At Grau we understand the importance of the environment and we are committed to sustainability and fair trade. Our products are manufactured in Sant Eugènia de Berga near Barcelona in Spain using locally sourced materials to minimise our environmental impact.

Grau products are designed and manufactured to have long lives, so reducing our use of the Earth's raw materials. During the manufacturing process, we deploy different methods and technologies to reduce contamination, including the use of renewable energy and recycling.



↑ COMPROMETIDOS CON EL MEDIO AMBIENTE / COMMITTED TO THE ENVIRONMENT

ES

Nuestra filosofía defiende que un entorno sostenible para los estudiantes ayuda a que crezcan pensando en proyectos que respeten el medio ambiente. Por eso en Grau vamos de la mano con la educación pensando en el futuro de nuestros jóvenes.

EN

Our philosophy is based on the idea that a sustainable environment helps students to develop thinking of projects that are environmentally friendly. In this way, we are walking hand in hand with the world of education, thinking of our young people's futures.





## Servicios — *Services*

↑ FABRICACIÓN PROPIA / IN-HOUSE PRODUCTION

### 01. EMPRESA / COMPANY



#### Fabricación propia — *In-house production*

**ES** Somos fabricantes consolidados y con experiencia en el sector desde 1955. Nuestras instalaciones de Santa Eugènia de Berga (España) cuentan con más de 6.000 m<sup>2</sup> con maquinaria de última generación.

**EN** We are an established manufacturing business with experience in the industry dating back to 1955. Our facilities near Barcelona have a surface area in excess of 6.000 m<sup>2</sup> with state-of-the-art machinery.



#### Durabilidad — *Durability*

Mobiliario diseñado para soportar el uso intensivo. Mesas con estructuras metálicas soldadas, superficies de trabajo indivisibles sin aristas vivas y de alta resistencia a los impactos y una pintura de máxima adhesión son la garantía de durabilidad de los productos Grau.

Furniture designed to withstand intensive use. Tables with welded metal frames, unbreakable work surfaces without any sharp edges and highly resistant to impact and maximum adhesion paint ensure the durability of Grau products.



#### Diseño innovador — *Innovative designs*

Departamento técnico propio de I+D para el desarrollo continuo de productos, aportando diseño y ergonomía sin prescindir de los estándares de calidad y durabilidad de Grau.

We have in-house technical and R&D departments for the continuous development of our products. They bring design and ergonomics together without compromising Grau's quality and durability standards.







**Envío a tiempo — On-time delivery**

**ES** Servicio de logística y coordinación de entregas riguroso, siempre a punto para hacer llegar el mobiliario a tiempo y dentro del plazo establecido con el cliente.

**EN** Exacting logistics and delivery planning, always ready to get our furniture to the customer on time within the agreed time frame.



**Asesoramiento personal — Personalised advice**

Un equipo humano profesional para el asesoramiento personalizado a nuestros clientes. Mejores resultados gracias a la interacción directa entre cliente y fabricante. Posibilidad de estudiar proyectos a medida.

Expert advisers to give personalised advice to each customer. The best results thanks to direct dialogue between customer and manufacturer. We can consider bespoke projects.



† EQUIPADOS CON LA ÚLTIMA TECNOLOGÍA / EQUIPPED WITH STATE-OF-THE-ART TECHNOLOGY



↓ SERVICIO DE LOGÍSTICA / LOGISTICS SERVICE



**Totalmente montado — Fully assembled**

**ES** Con el objetivo de asegurar un funcionamiento óptimo y seguro y de evitar incidencias durante el montaje, el mobiliario de Grau se entrega siempre totalmente montado desde fábrica.

**EN** To ensure optimal, safe performance and to avoid incidents during assembly, all Grau furniture is delivered fully factory-assembled.



**Siempre contigo — Always at your side**

Ofrecemos soporte técnico y asesoramiento, no solo durante el proceso de compra, sino también con un servicio posventa en todos los productos Grau.

We offer technical support and advice, not only during the buying process but also with an after-sales service for all Grau products.

# Ambientes *Environments*



# Colaborativo *Collaborative*

PRODUCTOS  
COMBINADOS / COMBINED  
PRODUCTS

PUPITRE / DESK  
**ECLIPSE**

BANDEJA / TRAY  
**BOX**

SILLA / CHAIR  
**SOFT R**

GRADA / TIERED SEATS  
**AGORA**  
**AGORA C**

PERCHA / COATHOOKS  
**CADI**



Colaborativo  
*Collaborative*

02. AMBIENTES / ENVIRONMENTS



PRODUCTOS  
COMBINADOS / COMBINED  
PRODUCTS

PUPITRE / DESK  
**PETAL**

BANDEJA / TRAY  
**BOX**

SILLA / CHAIR  
**SOFT**

ALMACENAJE / STORAGE  
**DOT 159 M**  
**DOT 159 C**  
**DOT 159 P**

PERCHA / COAT HOOKS  
**CADI**

ACCESORIOS / ACCESSORIES  
**PIZARRA / WHITEBOARD**

PRODUCTOS  
COMBINADOS / COMBINED  
PRODUCTS

MESA / TABLE  
**KIDDY R**  
**KIDDY SC**

SILLA / CHAIR  
**PIVOT**  
**KIDDY VINTA**

ALMACENAJE / STORAGE  
**DOT 82 C**  
**DOT 82 A**

PERCHA / COATHOOKS  
**CADI PLUS**

# Infantil *Infants*





Infantil  
*Infants*

PRODUCTOS  
COMBINADOS / COMBINED  
PRODUCTS

MESA / TABLE  
**TWIST OVAL  
DISC UP**

SILLA / CHAIR  
**KIDDY COSY**

## Conventional *Conventional*

PRODUCTOS  
COMBINADOS / COMBINED  
PRODUCTS

PUPITRE / DESK  
DESK ONE

BANDEJA / TRAY  
BOX

MESA / TABLE  
PROF

SILLA / CHAIR  
SLIM  
SLIM PROF

ALMACENAJE / STORAGE  
DOT 197 T

ACCESORIOS / ACCESSORIES  
PIZARRA / WHITEBOARD



# Biblioteca *Library*

PRODUCTOS  
COMBINADOS / COMBINED  
PRODUCTS

MESA / TABLE  
**LINE**

SILLA / CHAIR  
**WOODY**

ALMACENAJE / STORAGE  
**DOT 197 T**  
**DOT 197 E**  
**DOT 197 R**





## Comedor *Dining hall*

PRODUCTOS  
COMBINADOS / COMBINED  
PRODUCTS

MESA / TABLE  
**KIDDY M**  
**TWIST R**  
**LINE**

SILLA / CHAIR  
**KIDDY COSY**  
**COSY**  
**SLIM**

ALMACENAJE / STORAGE  
**DOT 197 M**  
**DOT 82 P**

# Productos *Products*



Pupitres — *Desks*



# Desk One



ES

El pupitre Desk One, líneas puras. Siguiendo los valores de concepción y fabricación que Grau impregna en todas sus creaciones. Minimalista, simétrico, sin aristas vivas y diseñado para un uso prolongado. Versátil para la educación colaborativa o tradicional. Se entrega totalmente montado.

EN

The Desk One desk, pure lines. Following the values of concept and manufacture that Grau embodies in all its creations. Minimalist, symmetrical, with no sharp edges and designed for long use. Versatile for collaborative or traditional learning. Supplied fully assembled.



## ACCESORIOS / ACCESSORIES



Bandeja inyectada con polipropileno reforzado / Tray injection-moulded in reinforced polypropylene

## ACABADOS / FINISHES



CDF BLANCO / WHITE CDF (16.4mm)  
Fibras de densidad compacta / Compact density fibres

FENÓLICO BLANCO / WHITE PF RESIN (12mm)  
Resina fenólica, hidrófuga y de alta resistencia / White phenolic resin, water resistant and very strong

FENÓLICO MADERA NÓRDICO / NORDIC WOOD PF RESIN (12mm)  
Resina fenólica, hidrófuga y de alta resistencia / Phenolic resin, water resistant and very strong

ESTRUCTURA METÁLICA SOLDADA / WELDED METAL FRAME (Ø30x1.5mm)  
Pintura en polvo epoxi blanca RAL9010 microtexturada / Microtexture white epoxy powder coating RAL9010

## \*MEDIDAS / MEASUREMENTS

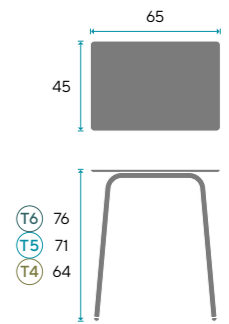

\* Todas las medidas son en centímetros / All measurements are in centimetres

## Desk Two

Pupitre doble para optimizar el espacio en áreas reducidas. / Double desk to optimise the use of space in small areas.

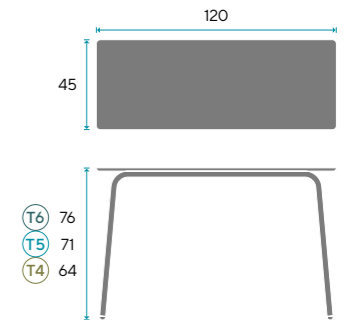

## COLABORATIVO / COLLABORATIVE

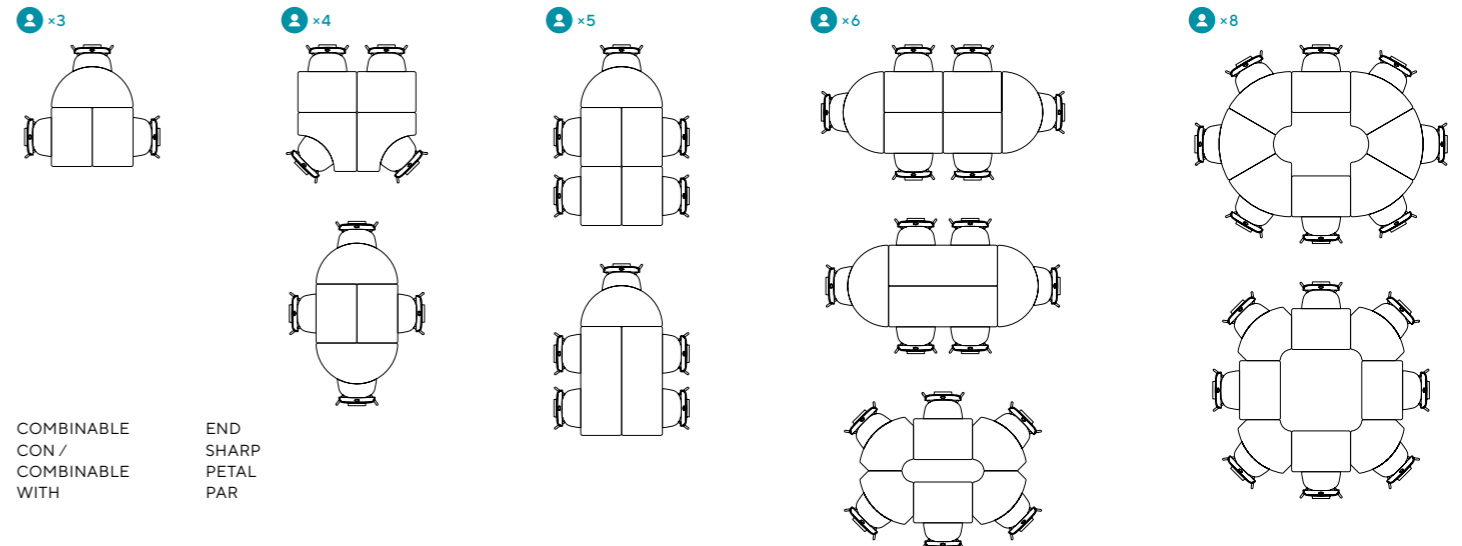

COMBINABLE CON / COMBINABLE WITH

END SHARP PETAL PAR

# Eclipse



**ES**

El pupitre Eclipse, fusión. Siguiendo los valores de concepción y fabricación que Grau impregna en todas sus creaciones. Minimalista, apilable, formas orgánicas y diseñado para un uso prolongado. Idóneo para la educación colaborativa. Se entrega totalmente montado.

APILABLE  
STACKABLE



**EN**

The Eclipse desk, fusion. Following the values of concept and manufacture that Grau embodies in all its creations. Minimalist, stackable, organic forms and designed for long use. Ideal for collaborative learning. Delivered fully assembled.

**ACCESORIOS / ACCESSORIES**

GRAFITO  
GRAPHITE



TURQUESA  
TURQUOISE



OLIVA  
OLIVE



MOSTAZA  
MUSTARD



Bandeja inyectada con polipropileno reforzado /  
Tray injection-moulded in reinforced polypropylene

**ACABADOS / FINISHES**



CDF BLANCO / WHITE CDF (16.4mm)  
Fibras de densidad compacta / Compact density fibres



FENÓLICO BLANCO / WHITE PF RESIN (12mm)  
Resina fenólica, hidrófuga y de alta resistencia /  
White phenolic resin, water resistant and very strong



FENÓLICO MADERA NÓRDICO / NORDIC  
WOOD PF RESIN (12mm)  
Resina fenólica, hidrófuga y de alta resistencia /  
Phenolic resin, water resistant and very strong



ESTRUCTURA METÁLICA SOLDADA / WELDED  
METAL FRAME (Ø30x1.5mm)  
Pintura en polvo epoxi blanca RAL9010  
microtexturada / Microtexture white epoxy powder  
coating RAL9010

**\*MEDIDAS / MEASUREMENTS**

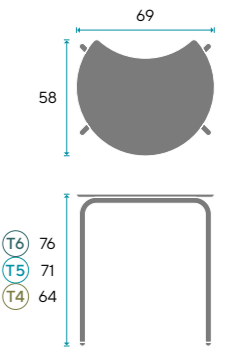

\* Todas las medidas son en centímetros / All  
measurements are in centimetres

**COLABORATIVO / COLLABORATIVE**

2 x 2



3 x 3

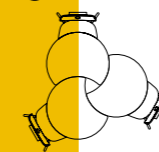

4 x 4

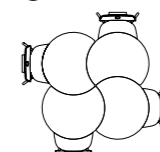

5 x 5

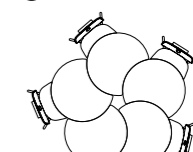

# Petal



ES

El pupitre Petal, armonía con la naturaleza. Siguiendo los valores de concepción y fabricación que Grau impregna en todas sus creaciones. Minimalista, formas orgánicas y diseñado para un uso prolongado. Idóneo para la educación colaborativa. Se entrega totalmente montado.

EN

The Petal desk, harmony with nature. Following the values of concept and manufacture that Grau embodies in all its creations. Minimalist, organic forms and designed for long use. Ideal for collaborative learning. Delivered fully assembled.

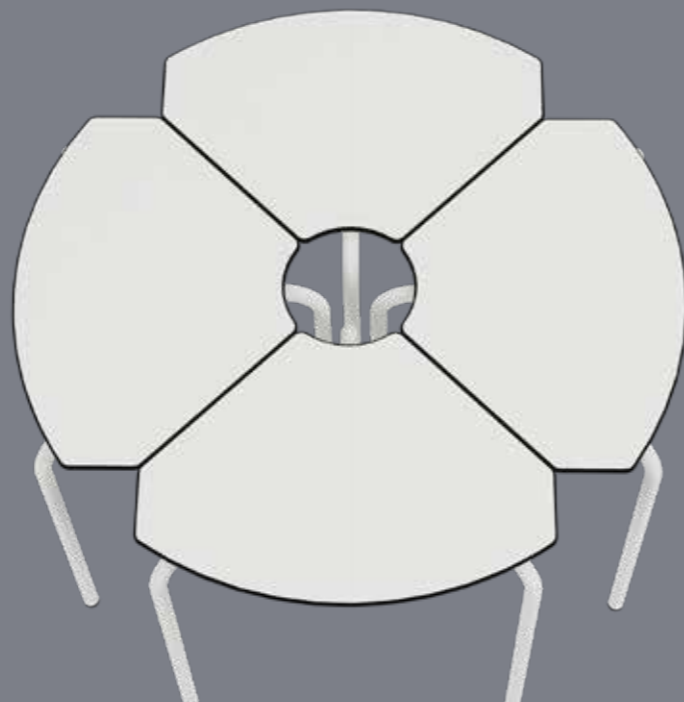

## ACCESORIOS / ACCESSORIES



Bandeja inyectada con polipropileno reforzado / Tray injection-moulded in reinforced polypropylene

## ACABADOS / FINISHES



CDF BLANCO / WHITE CDF (16.4mm)  
Fibras de densidad compacta / Compact density fibres

FENÓLICO BLANCO / WHITE PF RESIN (12mm)  
Resina fenólica, hidrófuga y de alta resistencia / White phenolic resin, water resistant and very strong

FENÓLICO MADERA NÓRDICO / NORDIC WOOD PF RESIN (12mm)  
Resina fenólica, hidrófuga y de alta resistencia / Phenolic resin, water resistant and very strong

ESTRUCTURA METÁLICA SOLDADA / WELDED METAL FRAME (Ø30x1.5mm)  
Pintura en polvo epoxi blanca RAL9010 microtexturada / Microtexture white epoxy powder coating RAL9010

## \*MEDIDAS / MEASUREMENTS

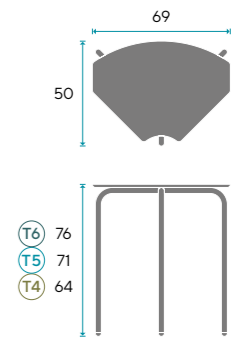

\* Todas las medidas son en centímetros / All measurements are in centimetres

## COLABORATIVO / COLLABORATIVE

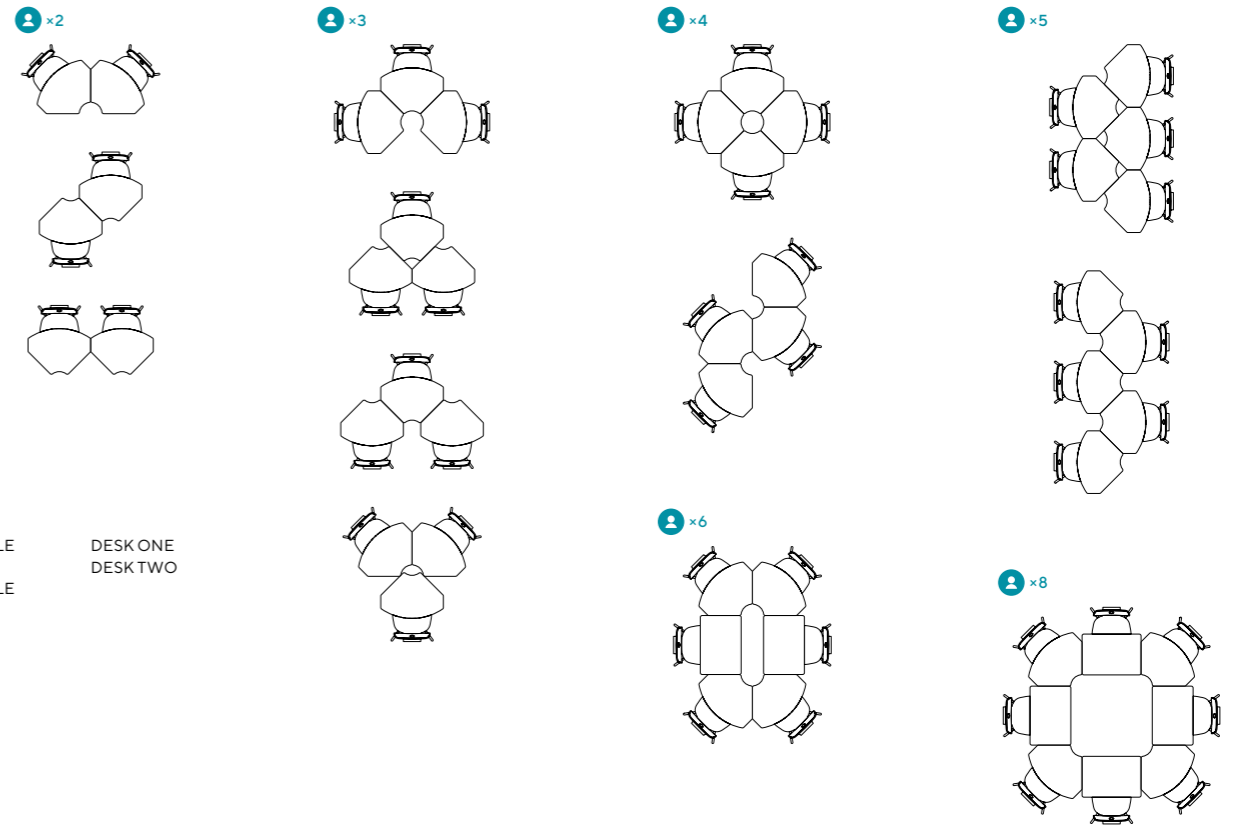

COMBINABLE CON / COMBINABLE WITH

DESK ONE  
DESK TWO

# End

ES

El pupitre End, acabado perfecto. Siguiendo los valores de concepción y fabricación que Grau impregna en todas sus creaciones. Minimalista, sin aristas vivas y diseñado para un uso prolongado. Idóneo para la educación colaborativa. Se entrega totalmente montado.

EN

The End desk, a perfect finish. Following the concept and manufacture that Grau embodies in all its creations. Minimalist, with no sharp edges and designed for long use. Ideal for collaborative learning. Supplied fully assembled.



## ACCESORIOS / ACCESSORIES



Bandeja inyectada con polipropileno reforzado /  
Tray injection-moulded in reinforced polypropylene

## ACABADOS / FINISHES

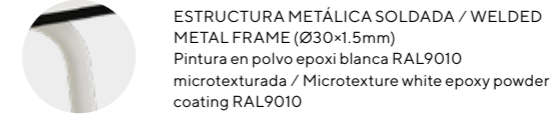
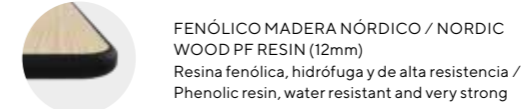
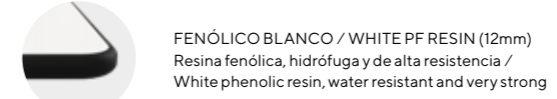
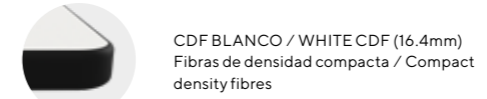

## \*MEDIDAS / MEASUREMENTS

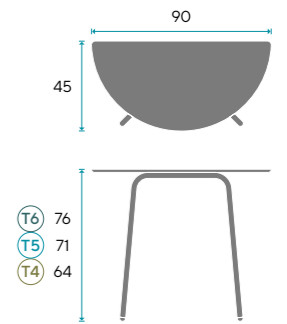

\* Todas las medidas son en centímetros / All  
measurements are in centimetres

## COLABORATIVO / COLLABORATIVE

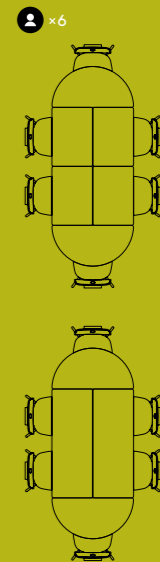
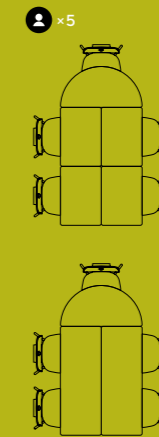
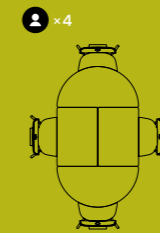
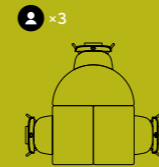

COMBINABLE  
CON /  
COMBINABLE  
WITH

DESK ONE  
DESK TWO



# Par



ES

El pupitre Par, conectividad. Siguiendo los valores de concepción y fabricación que Grau impregna en todas sus creaciones. Minimalista, sin aristas vivas y diseñado para un uso prolongado. Idóneo para la educación colaborativa. Se entrega totalmente montado.

EN

The Par desk, connectivity. Following the values of concept and manufacture that Grau embodies in all its creations. Minimalist, with no sharp edges and designed for long use. Ideal for collaborative learning. Supplied fully assembled.

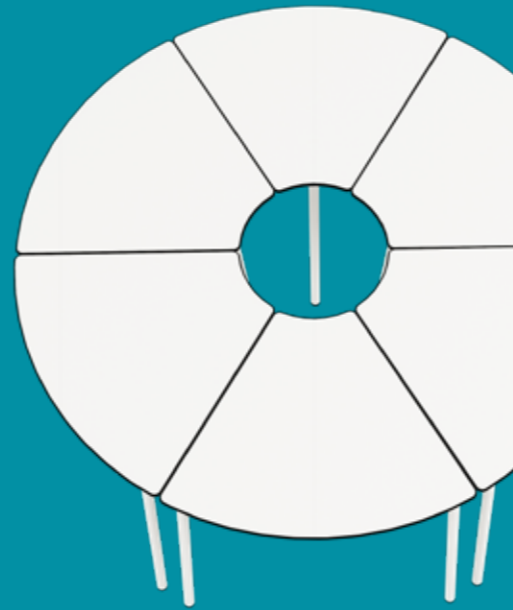

## ACCESORIOS / ACCESSORIES



Bandeja inyectada con polipropileno reforzado / Tray injection-moulded in reinforced polypropylene

## ACABADOS / FINISHES



## \*MEDIDAS / MEASUREMENTS

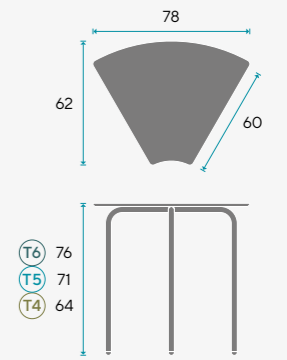

\* Todas las medidas son en centímetros / All measurements are in centimetres

## COLABORATIVO / COLLABORATIVE

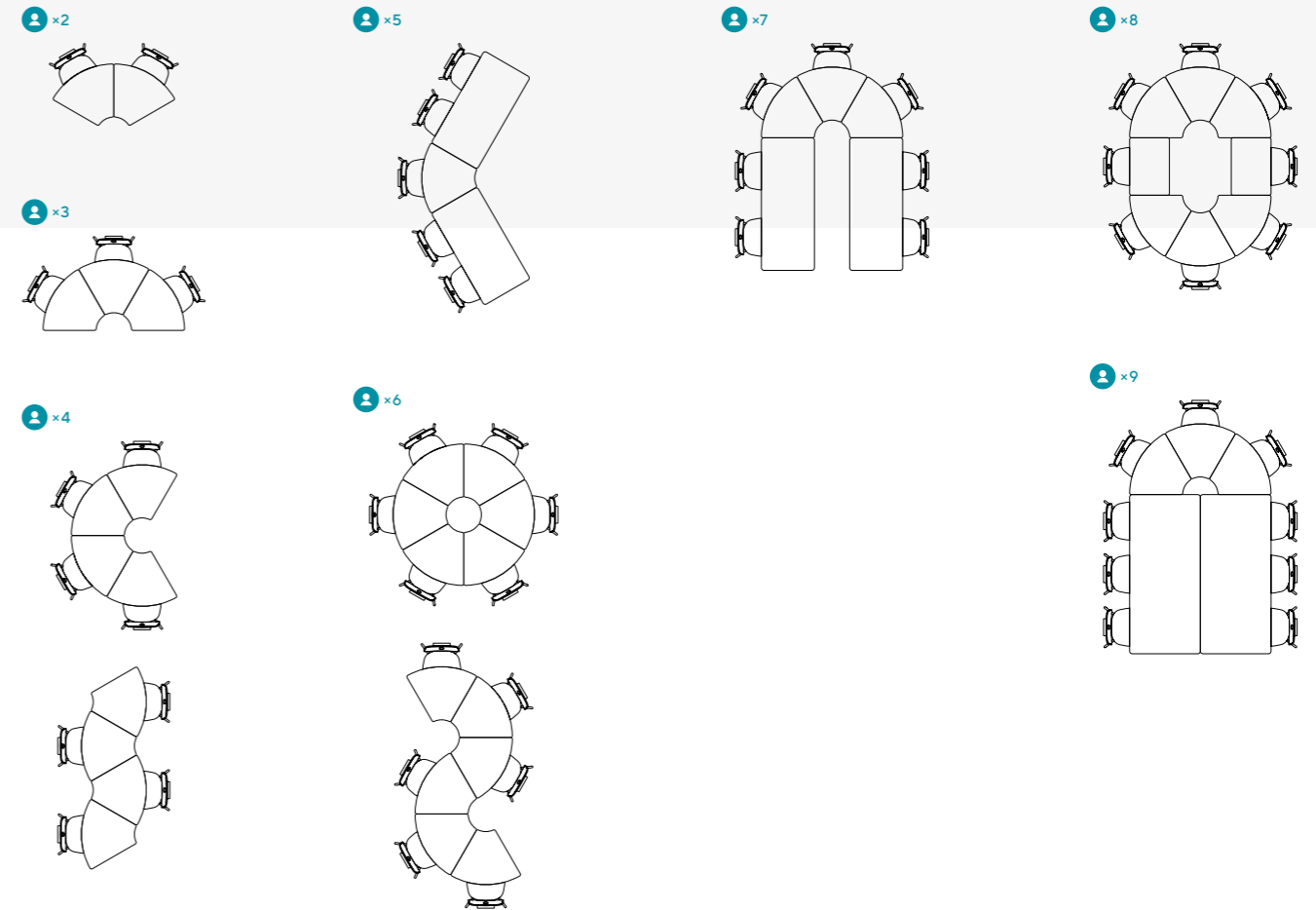

COMBINABLE CON / COMBINABLE WITH  
DESK ONE  
DESK TWO

# Sharp



ES

El pupitre Sharp define la dirección. Siguiendo los valores de concepción y fabricación que Grau impregna en todas sus creaciones. Posición izquierda, derecha o frontal. Minimalista, sin aristas vivas y diseñado para un uso prolongado. Idóneo para la educación colaborativa. Se entrega totalmente montado.

EN

The Sharp desk, defines direction. Following the values of concept and manufacture that Grau embodies in all its creations. Can be joined left and right or front and designed for long use. Ideal for collaborative learning. Supplied fully assembled.

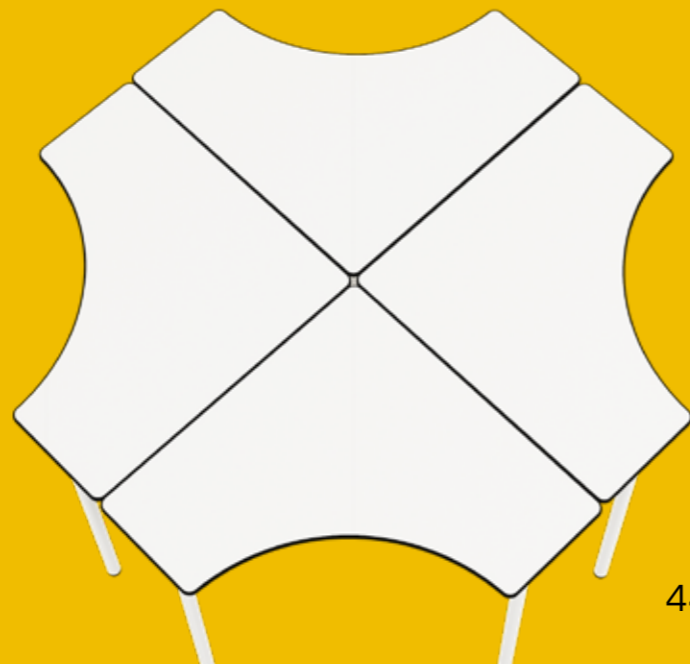

## ACCESORIOS / ACCESSORIES



Bandeja inyectada con polipropileno reforzado / Tray injection-moulded in reinforced polypropylene

## ACABADOS / FINISHES



CDF BLANCO / WHITE CDF (16.4mm)  
Fibras de densidad compacta / Compact density fibres

FENÓLICO BLANCO / WHITE PF RESIN (12mm)  
Resina fenólica, hidrófuga y de alta resistencia / White phenolic resin, water resistant and very strong

FENÓLICO MADERA NÓRDICO / NORDIC WOOD PF RESIN (12mm)  
Resina fenólica, hidrófuga y de alta resistencia / Phenolic resin, water resistant and very strong

ESTRUCTURA METÁLICA SOLDADA / WELDED METAL FRAME (Ø30x1.5mm)  
Pintura en polvo epoxi blanca RAL9010 microtexturada / Microtexture white epoxy powder coating RAL9010

## \*MEDIDAS / MEASUREMENTS

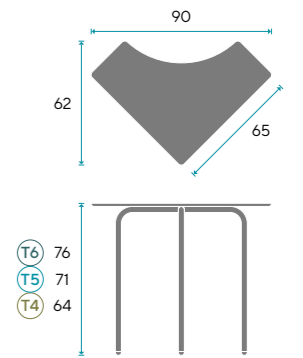

\* Todas las medidas son en centímetros / All measurements are in centimetres

## COLABORATIVO / COLLABORATIVE

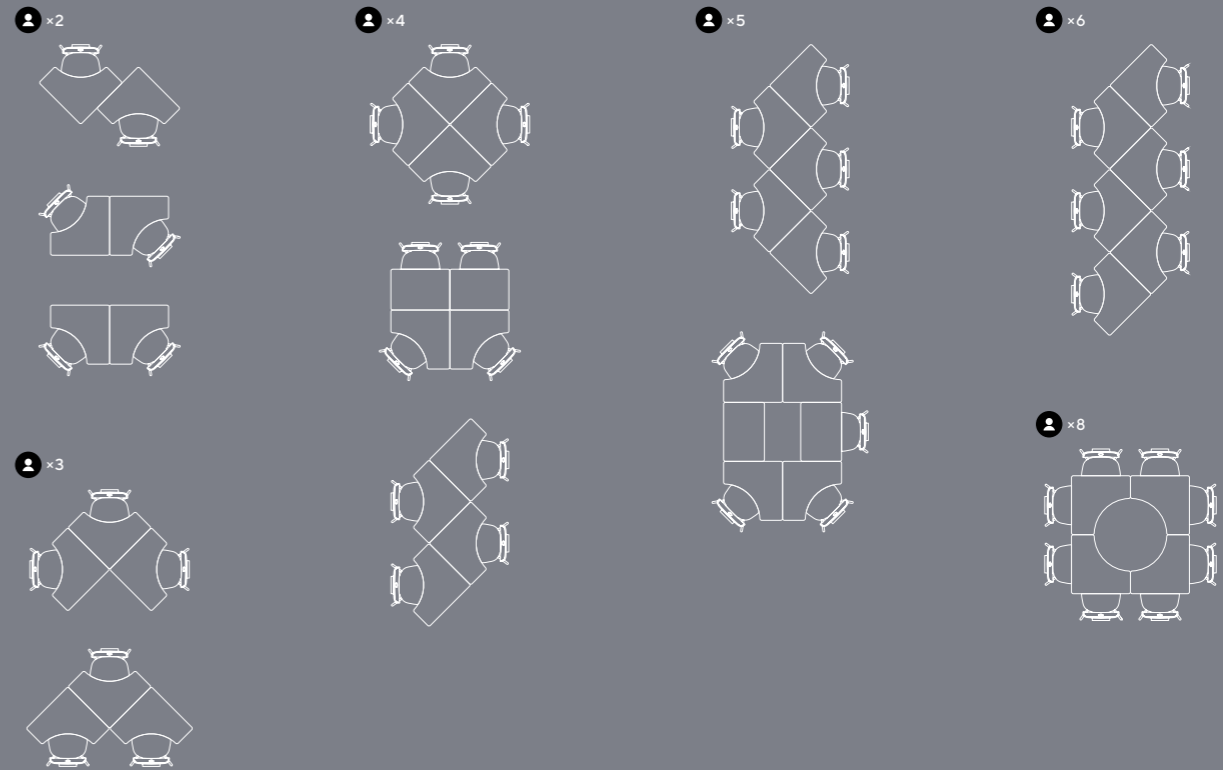

COMBINABLE CON / COMBINABLE WITH

DESK ONE / DESK TWO



# Pile



ES

EN

El pupitre Pile, verticalidad. Siguiendo los valores de concepción y fabricación que Grau impregna en todas sus creaciones. Minimalista, apilable frontalmente, sin aristas vivas y diseñado para un uso prolongado. Versátil para la educación colaborativa o tradicional. Se entrega totalmente montado.

The Pile desk, verticality. Following the values of concept and manufacture that Grau embodies in all its creations. Minimalist, frontally stackable longways, with no sharp edges and designed for long use. Versatile for collaborative and traditional learning. Supplied fully assembled.

APILABLE  
STACKABLE



## ACCESORIOS / ACCESSORIES



Bandeja inyectada con polipropileno reforzado /  
Tray injection-moulded in reinforced polypropylene

## ACABADOS / FINISHES

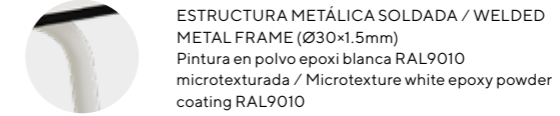
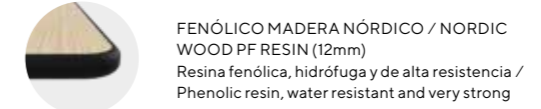
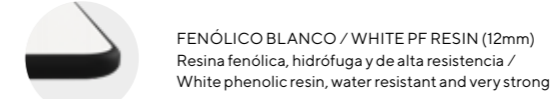
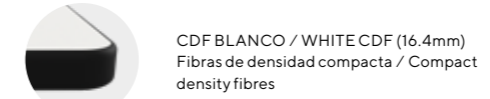

## \* MEDIDAS / MEASUREMENTS

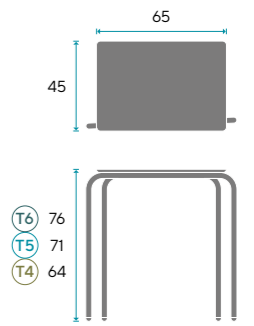

\* Todas las medidas son en centímetros / All  
measurements are in centimetres

## COLABORATIVO / COLLABORATIVE

2

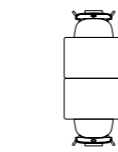

4

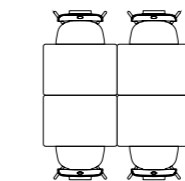

5

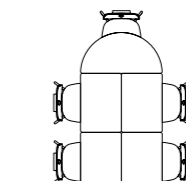

8

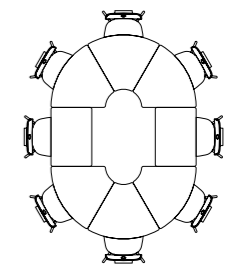

3

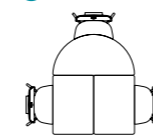

4

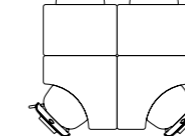

6

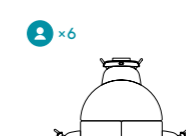

8

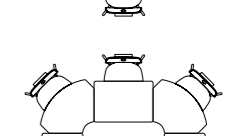

COMBINABLE  
CON /  
COMBINABLE  
WITH

END  
SHARP  
PETAL  
PAR

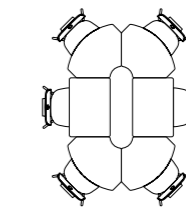
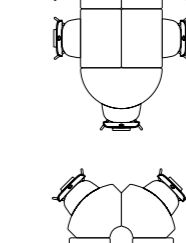
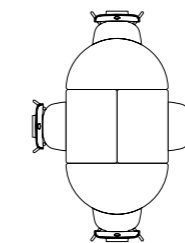

PUPITRE / DESK

# Box

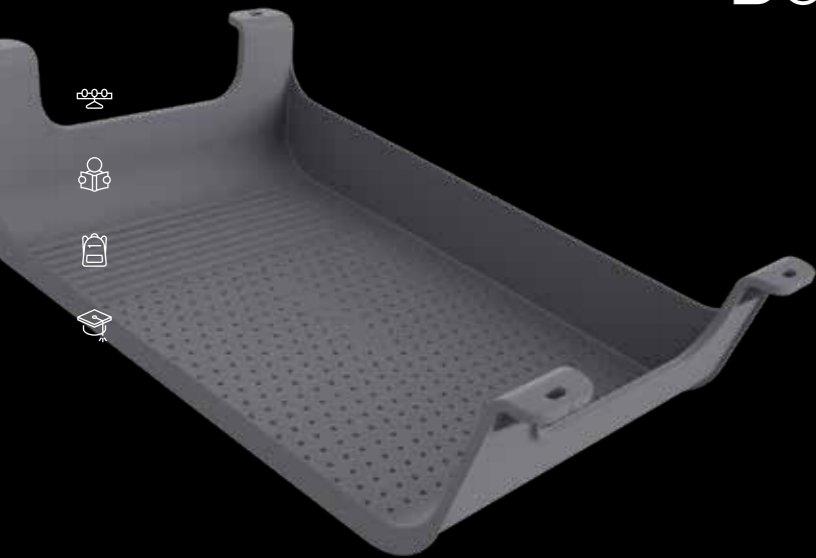

BANDEJA / TRAY

COLORES / COLOURS



Bandeja inyectada con polipropileno reforzado /  
Tray injection-moulded in reinforced polypropylene

CARACTERÍSTICAS / FEATURES



PARA ALMACENAJE  
FOR STORAGE



\*MEDIDAS / MEASUREMENTS

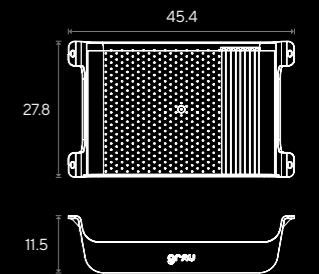

\* Todas las medidas son en centímetros / All  
measurements are in centimetres



APLICACIÓN / APPLICATION

Box  
+  
Desk Two

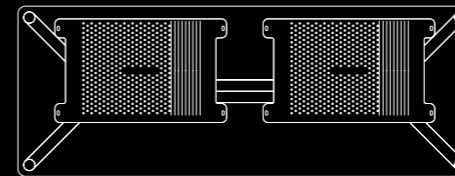

Box  
+  
Eclipse

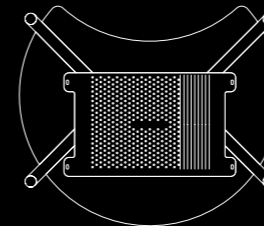

Box  
+  
End

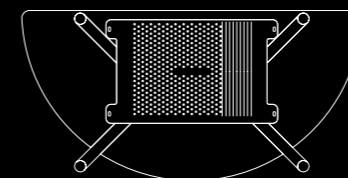

Box  
+  
Sharp

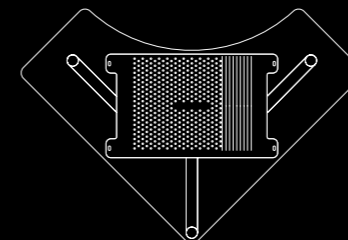

Box  
+  
Desk one

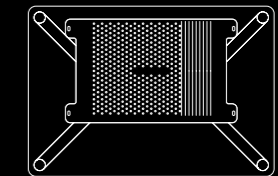

Box  
+  
Petal

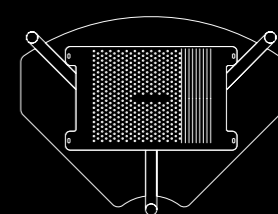

Box  
+  
Par

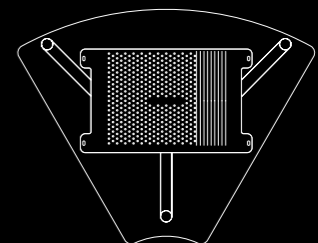

Box  
+  
Pile

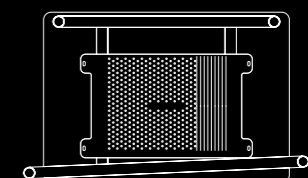

ES

La bandeja Box, cada cosa en su sitio. Siguiendo los valores de concepción y fabricación que Grau impregna en todas sus creaciones. Colores armónicos. Sin aristas vivas y diseñada para un uso prolongado. Versátil para la educación colaborativa o tradicional. Se entrega totalmente montada.

EN

The Box tray, everything in its place. Following the values of concept and manufacture that Grau embodies in all its creations. Harmonious colours. No sharp edges and designed for long use. Versatile for collaborative and traditional learning. Supplied fully assembled.

# Productos *Products*



Mesas — *Tables*



# Twist Oval

ES

La mesa Twist, polivalencia absoluta. Siguiendo los valores de concepción y fabricación que Grau impregna en todas sus creaciones. Minimalista, con ruedas, plegable, con opción rotulable. Sin aristas vivas y diseñada para un uso prolongado. Versátil para la educación colaborativa y comedores. Se entrega totalmente montada.

EN

The Twist table, total versatility. Following the values of concept and manufacture that Grau embodies in all its creations. Minimalist, with casters, foldable and usable as a whiteboard (optional). No sharp edges and designed for long use. Versatile for collaborative learning and dining halls. Supplied fully assembled.



PLEGABLE FOLDABLE



ROTULABLE WHITEBOARD

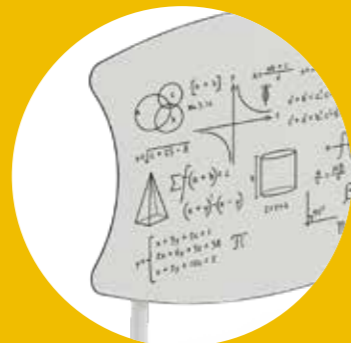

CON FRENOS WITH BRAKES



## ACABADOS / FINISHES



CDF BLANCO / WHITE CDF (16.4mm)  
Fibras de densidad compacta / Compact density fibres



FENÓLICO BLANCO / WHITE PF RESIN (12mm)  
Resina fenólica, hidrófuga y de alta resistencia / White phenolic resin, water resistant and very strong

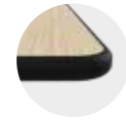

FENÓLICO MADERA NÓRDICO / NORDIC WOOD PF RESIN (12mm)  
Resina fenólica, hidrófuga y de alta resistencia / Phenolic resin, water resistant and very strong



MELAMINA ROTULABLE / MARKABLE MELAMINE (19mm)  
Canteadado PVC / PVC edges



ESTRUCTURA METÁLICA SOLDADA / WELDED METAL FRAME  
Pintura en polvo epoxi blanca RAL9010 microtexturada / Microtexture white epoxy powder coating RAL9010

## \* MEDIDAS / MEASUREMENTS

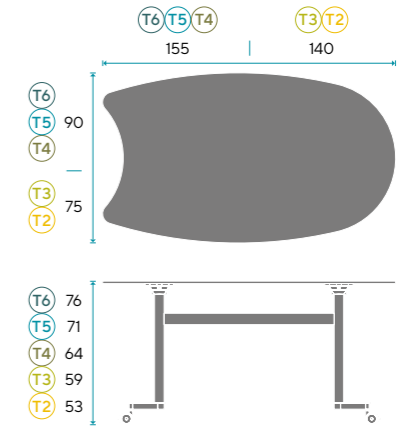

\* Todas las medidas son en centímetros / All measurements are in centimetres

## Twist R

### VERSIONES / VERSIONS



PLEGABLE FOLDABLE

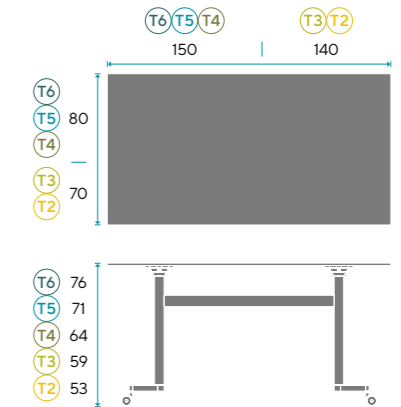
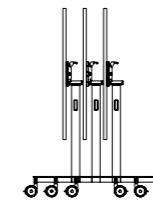

### COLABORATIVO / COLLABORATIVE

8

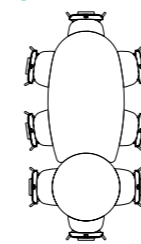

12

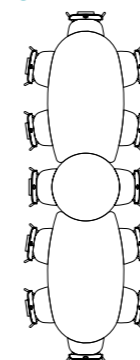

14

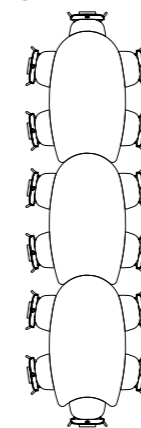

15

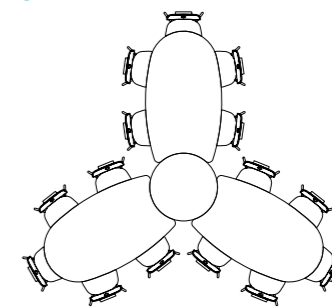

17

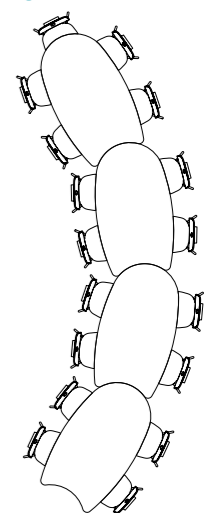

COMBINABLE CON / COMBINABLE WITH

DISC UP

# Disc Up

ES

La mesa Disc Up, no importa la altura. Siguiendo los valores de concepción y fabricación que Grau impregna en todas sus creaciones. Circular y minimalista, altura regulable y diseñada para un uso prolongado. Idónea para la educación colaborativa. Se entrega totalmente montada.

EN

The Disc Up table, height is no object. Following the values of concept and manufacture that Grau embodies in all its creations. Round and minimalist, adjustable height and designed for long use. Ideal for collaborative learning. Supplied fully assembled.

## ACABADOS / FINISHES



CDF BLANCO / WHITE CDF (16.4mm)  
Fibras de densidad compacta / Compact density fibres



FENÓLICO BLANCO / WHITE PF RESIN (12mm)  
Resina fenólica, hidrófuga y de alta resistencia / White phenolic resin, water resistant and very strong



FENÓLICO MADERA NÓRDICO / NORDIC WOOD PF RESIN (12mm)  
Resina fenólica, hidrófuga y de alta resistencia / Phenolic resin, water resistant and very strong



ESTRUCTURA METÁLICA SOLDADA / WELDED METAL FRAME  
Pintura en polvo epoxi blanca RAL9010 microtexturada / Microtexture white epoxy powder coating RAL9010

## \* MEDIDAS / MEASUREMENTS

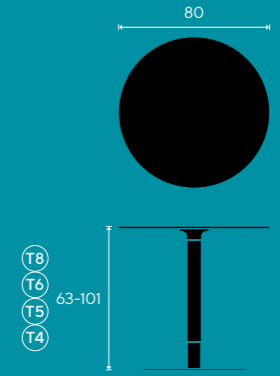

\* Todas las medidas son en centímetros / All measurements are in centimetres

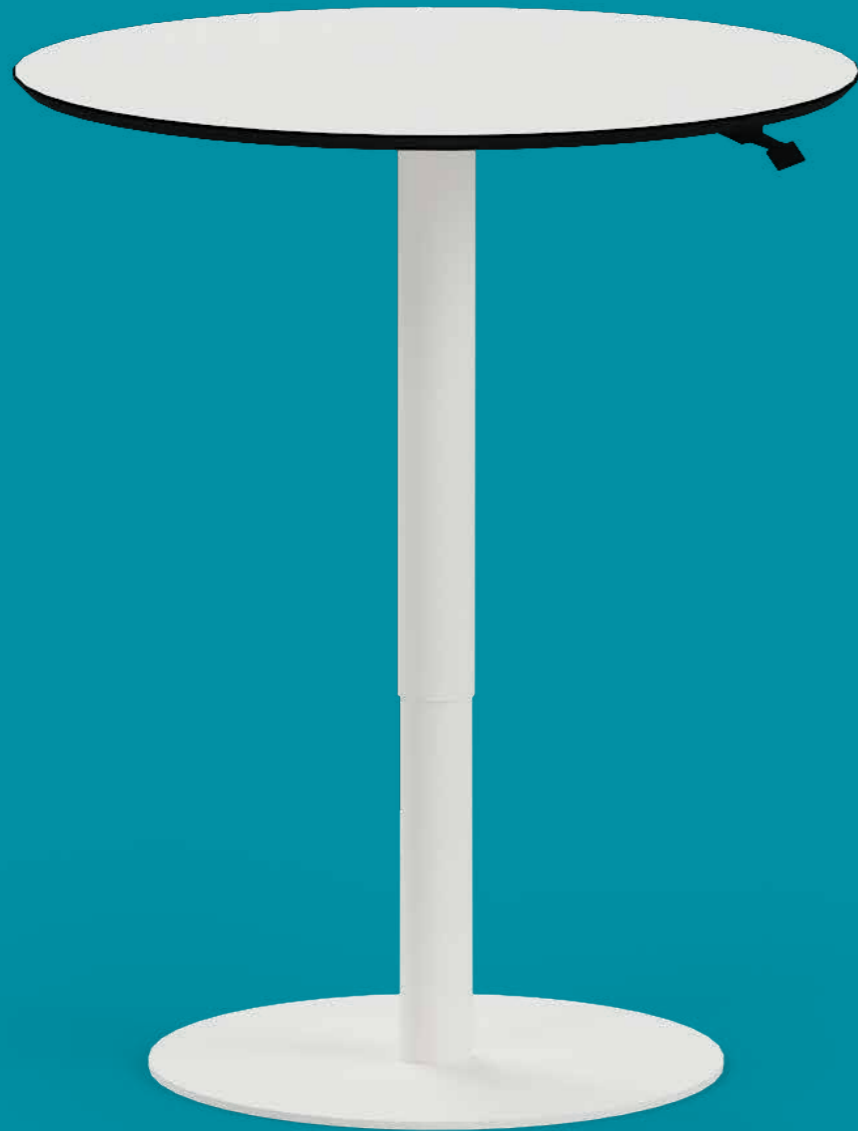

## CARACTERÍSTICAS / FEATURES

ALTURA REGULABLE  
ADJUSTABLE  
HEIGHT



## COLABORATIVO / COLLABORATIVE

8



12

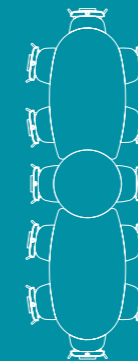

15

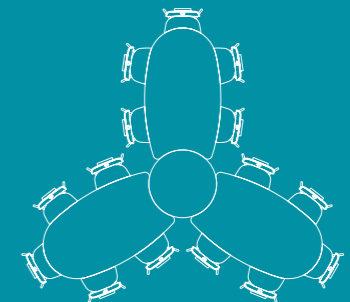

COMBINABLE  
CON /  
COMBINABLE  
WITH

TWIST OVAL

# Line



ES

La mesa Line, líneas sin fin. Siguiendo los valores de concepción y fabricación que Grau impregna en todas sus creaciones. Minimalista y robusta. Sin aristas vivas y diseñada para un uso prolongado. Versátil para la educación colaborativa o tradicional y para comedores. Se entrega totalmente montada.

EN

The Line table, unending lines. Following the values of concept and manufacture that Grau embodies in all its creations. Minimalist and robust. No sharp edges and designed for long use. Versatile for collaborative or traditional learning and dining halls. Supplied fully assembled.



NIVELADORES  
ADJUSTABLE FEET



## ACABADOS / FINISHES



CDF BLANCO / WHITE CDF  
(16.4mm)  
Fibras de densidad compacta /  
Compact density fibres



FENÓLICO BLANCO / WHITE PF  
RESIN (12mm)  
Resina fenólica, hidrófuga y de alta  
resistencia / White phenolic resin,  
water resistant and very strong

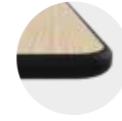

FENÓLICO MADERA NÓRDICO /  
NORDIC WOOD PF RESIN (12mm)  
Resina fenólica, hidrófuga y de alta  
resistencia / Phenolic resin, water  
resistant and very strong



ESTRUCTURA METÁLICA  
SOLDADA / WELDED METAL  
FRAME (PATAS / LEGS  
Ø40x1,5mm)  
Pintura en polvo epoxi blanca  
RAL9010 microtexturada /  
Microtexture white epoxy powder  
coating RAL9010

## ACCESORIOS / ACCESSORIES

FALDÓN FRONTAL  
FRONT PANEL

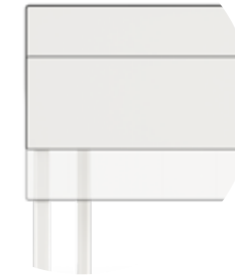

PASACABLES  
CABLE ENTRY



CANAL  
CABLE TRAY



CPU  
CPU



## \* MEDIDAS / MEASUREMENTS

Line 200

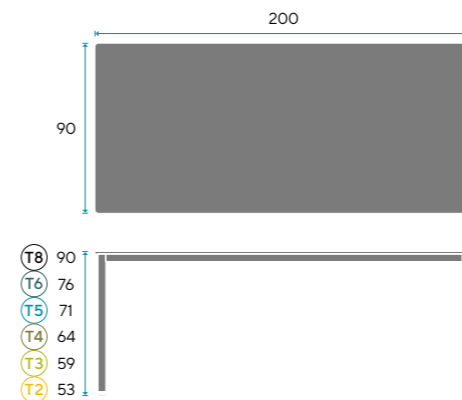

Line 180

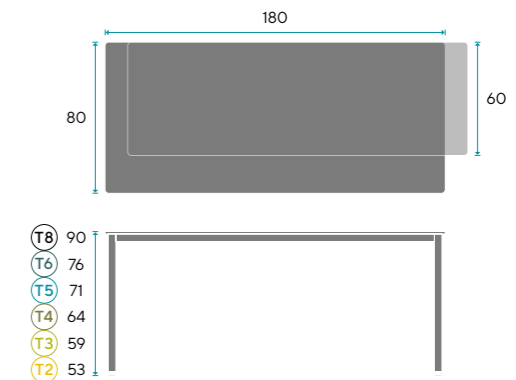

Line 150

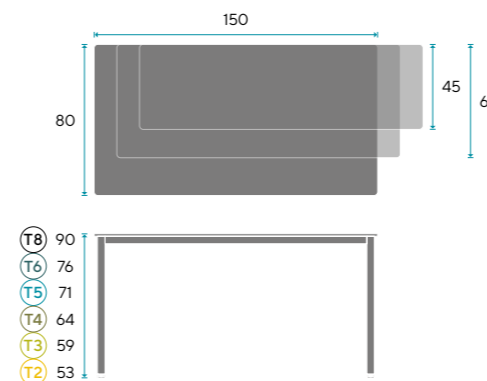

Line 120

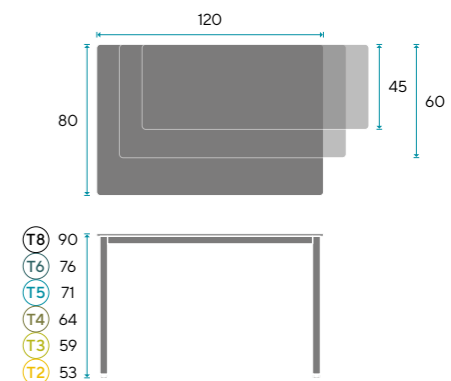

# Disc F



ES

La mesa Disc F, punto de encuentro. Siguiendo los valores de concepción y fabricación que Grau impregna en todas sus creaciones. Circular y minimalista. Diseñada para un uso prolongado. Idónea para la educación colaborativa. Se entrega totalmente montada.

EN

The Disk F table, meeting point. Following the values of concept and manufacture that Grau embodies in all its creations. Round and minimalist. Designed for long use. Ideal for collaborative learning. Supplied fully assembled.



## \* MEDIDAS / MEASUREMENTS

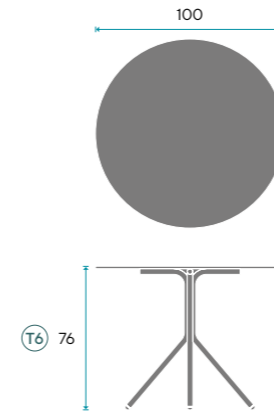

\* Todas las medidas son en centímetros / All measurements are in centimetres

## ACABADOS / FINISHES



CDF BLANCO / WHITE CDF (16.4mm)  
Fibras de densidad compacta / Compact density fibres



FENÓLICO BLANCO / WHITE PF RESIN (12mm)  
Resina fenólica, hidrófuga y de alta resistencia / White phenolic resin, water resistant and very strong

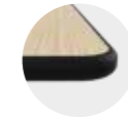

FENÓLICO MADERA NÓRDICO / NORDIC WOOD PF RESIN (12mm)  
Resina fenólica, hidrófuga y de alta resistencia / Phenolic resin, water resistant and very strong



ESTRUCTURA METÁLICA SOLDADA / WELDED METAL FRAME (Ø30x1.5mm)  
Pintura en polvo epoxi blanca RAL9010 microtexturada / Microtexture white epoxy powder coating RAL9010

# Prof



ES

La mesa Prof, donde todo empieza. Siguiendo los valores de concepción y fabricación que Grau impregna en todas sus creaciones. Minimalista y robusta. Sin aristas vivas y diseñada para un uso prolongado. Idónea para la educación colaborativa o tradicional. Se entrega totalmente montada.

EN

The Prof table, where everything begins. Following the values of concept and manufacture that Grau embodies in all its creations. Minimalist and robust. No sharp edges and designed for long use. Ideal for collaborative and traditional learning. Supplied fully assembled.



## \* MEDIDAS / MEASUREMENTS

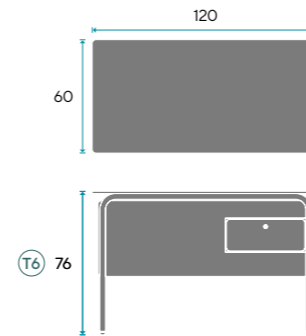

## ACABADOS / FINISHES



CDF BLANCO / WHITE CDF (16.4mm)  
Fibras de densidad compacta / Compact density fibres



FENÓLICO BLANCO / WHITE PF RESIN (12mm)  
Resina fenólica, hidrófuga y de alta resistencia / White phenolic resin, water resistant and very strong

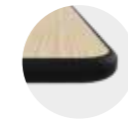

FENÓLICO MADERA NÓRDICO / NORDIC WOOD PF RESIN (12mm)  
Resina fenólica, hidrófuga y de alta resistencia / Phenolic resin, water resistant and very strong



ESTRUCTURA METÁLICA SOLDADA / WELDED METAL STRUCTURE (Ø30x1.5mm)  
Pintura en polvo epoxi blanca RAL9010 microtexturada / Microtexture white epoxy powder coating RAL9010

## ACCESORIOS / ACCESSORIES

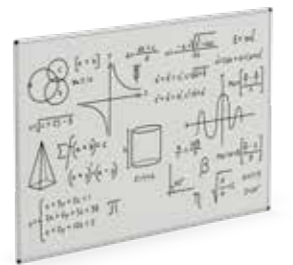

PIZARRA WHITEBOARD

# Duo



ES

La mesa Duo, ¡hora de comer! Siguiendo los valores de concepción y fabricación que Grau impregna en todas sus creaciones. Minimalista, robusta y con bancos plegables para facilitar la limpieza. Sin aristas vivas y diseñada para un uso prolongado. Idónea para comedores tradicionales. Se entrega totalmente montada.

EN

The Duo table, time for lunch! Following the values of concept and manufacture that Grau embodies in all its creations. Minimalist, robust and with foldable benches for cleaning. No sharp edges and designed for long use. Ideal for traditional dining halls. Supplied fully assembled.



## \* MEDIDAS / MEASUREMENTS

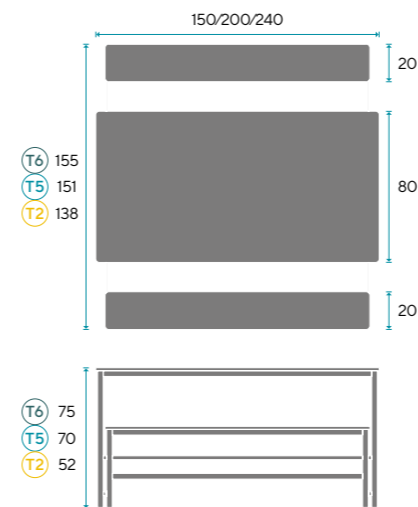

## ACABADOS / FINISHES



CDF BLANCO / WHITE CDF (16.4mm)  
Fibras de densidad compacta / Compact density fibres



ESTRUCTURA METÁLICA SOLDADA / WELDED METAL FRAME (30x30x1.5mm)  
Pintura en polvo epoxi blanca RAL9010 microtexturada / Microtexture white epoxy powder coating RAL9010

## CARACTERÍSTICAS / FEATURES

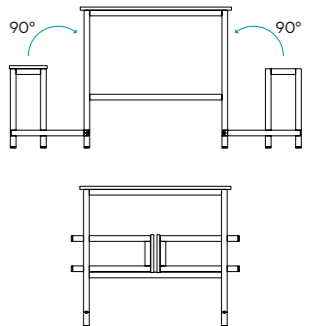

PLEGABLE FOLDABLE

# Productos *Products*



Sillas — *Chairs*





# Soft



ES

La silla Soft, dinamismo constante. Siguiendo los valores de concepción y fabricación que Grau impregna en todas sus creaciones. Ligera y dinámica. Colores armónicos. Sin aristas vivas y diseñada para un uso prolongado. Versátil para la educación colaborativa o tradicional. Se entrega totalmente montada.

EN

The Soft chair, constant dynamism. Following the values of concept and manufacture that Grau embodies in all its creations. Light and dynamic. Harmonious colours. No sharp edges and designed for long use. Versatile for collaborative or traditional learning. Supplied fully assembled.



GANCHO  
HOOK



APILABLE  
STACKABLE



ESTRUCTURA METÁLICA SOLDADA / WELDED  
METAL FRAME (Ø20x1.5mm)  
Pintura en polvo epoxi blanca RAL9010 microtexturada /  
Microtexture white epoxy powder coating RAL9010

## COLORES / COLOURS



GRAFITO  
GRAPHITE



TURQUESA  
TURQUOISE



OLIVA  
OLIVE



MOSTAZA  
MUSTARD

## \* MEDIDAS / MEASUREMENTS

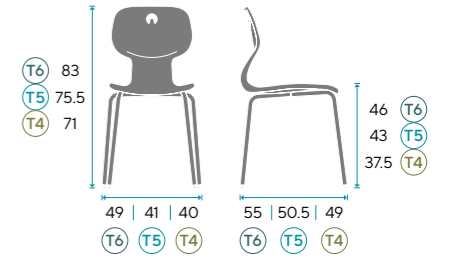

## VERSIONES / VERSIONS

### Soft R



CON RUEDAS  
WITH CASTERS

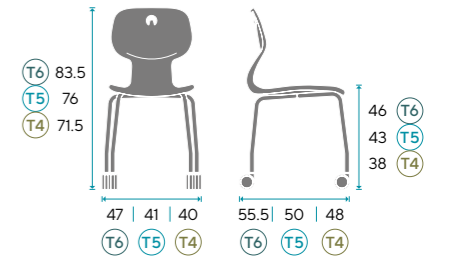
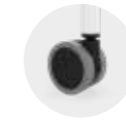

### Soft F

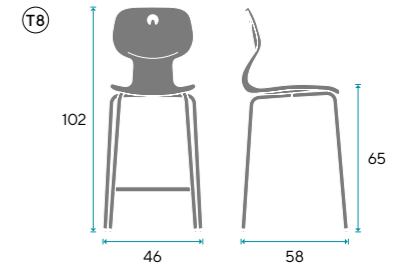

\* Todas las medidas son en centímetros / All measurements are in centimetres

# Slim

APILABLE  
STACKABLE



ESTRUCTURA METÁLICA SOLDADA /  
WELDED METAL FRAME (Ø22x1.5mm)  
Pintura en polvo epoxi blanco RAL9010  
microtexturado / Microtexture white epoxy  
powder coating RAL9010



ES

La silla Slim, una para todo. Siguiendo los valores de concepción y fabricación que Grau impregna en todas sus creaciones. Amplia gama, minimalista y ligera. Colores armónicos. Sin aristas vivas y diseñada para un uso prolongado. Versátil para la educación colaborativa o tradicional. Se entrega totalmente montada.

EN

The Slim chair, one for everyone. Following the values of concept and manufacture that Grau embodies in all its creations. Big range, minimalist and light. Harmonious colours. No sharp edges and designed for long use. Versatile for collaborative or traditional learning. Supplied fully assembled.

## COLORES / COLOURS



GRAFITO  
GRAPHITE



TURQUESA  
TURQUOISE



OLIVA  
OLIVE



MOSTAZA  
MUSTARD

## \*MEDIDAS / MEASUREMENTS

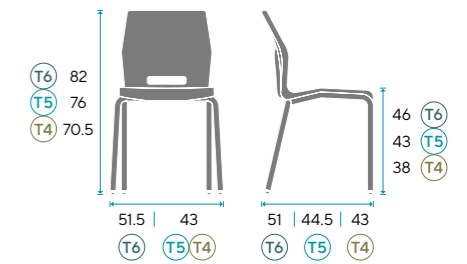

## VERSIONES / VERSIONS

### Slim R



CON RUEDAS  
WITH CASTERS

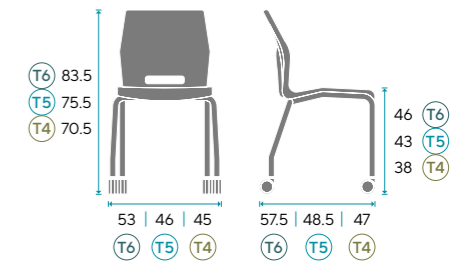

### Slim Up

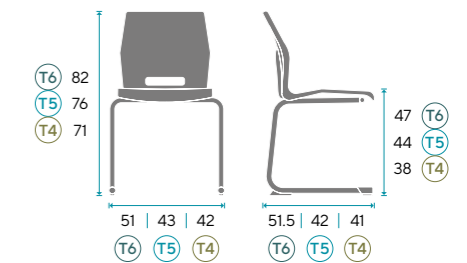

### Slim P

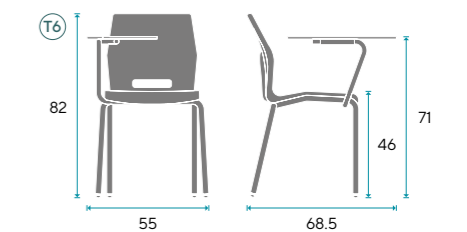

\* Todas las medidas son en centímetros / All measurements are in centimetres

# Slim F



ES

El taburete Slim, el más alto. Siguiendo los valores de concepción y fabricación que Grau impregna en todas sus creaciones. Taburete alto, minimalista y ligero. Colores armónicos. Sin aristas vivas y diseñado para un uso prolongado. Versátil para la educación colaborativa o tradicional. Se entrega totalmente montado.

EN

The Slim high stool, at the top. Following the values of concept and manufacture that Grau embodies in all its creations. High stool, minimalist and light. Harmonious colours. No sharp edges and designed for long use. Versatile for collaborative or traditional learning. Supplied fully assembled.

ESTRUCTURA METÁLICA SOLDADA / WELDED METAL FRAME (Ø22x1.5mm)  
Pintura en polvo epoxi blanco RAL9010 microtexturado / Microtexture white epoxy powder coating RAL9010

## COLORES / COLOURS

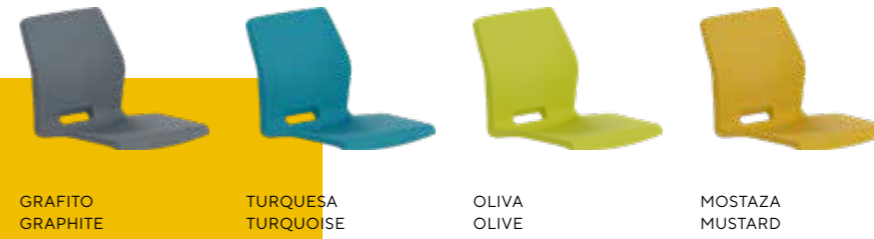

GRAFITO  
GRAPHITE

TURQUESA  
TURQUOISE

OLIVA  
OLIVE

MOSTAZA  
MUSTARD

## \*MEDIDAS / MEASUREMENTS

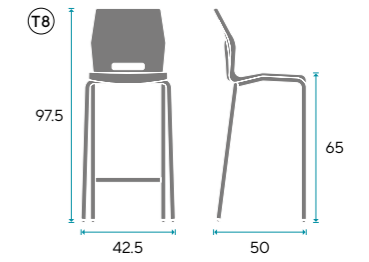

## Slim G

### VERSIONES / VERSIONS

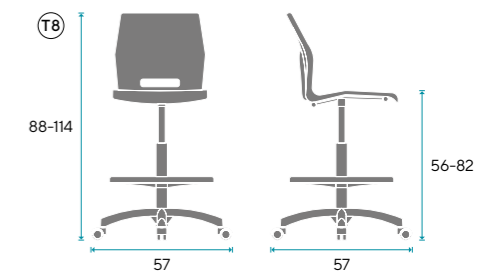

## Slim Prof

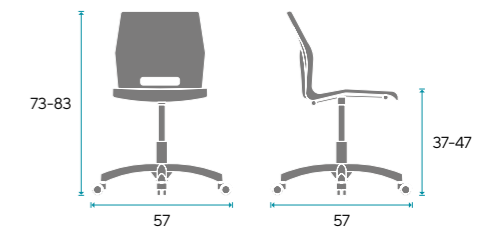

## Slim B



PIES CROMADOS  
CHROME PLATED FEET

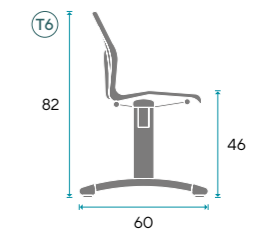
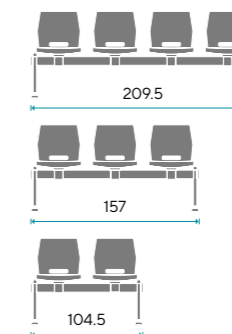

\* Todas las medidas son en centímetros / All measurements are in centimetres

## Vinta



APILABLE  
STACKABLE



GANCHO  
HOOK

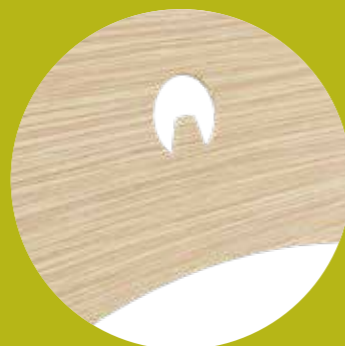

ES

La silla Vinta, la clásica. Siguiendo los valores de concepción y fabricación que Grau impregna en todas sus creaciones. Robusta y apilable. Sin aristas vivas y diseñada para un uso prolongado. Versátil para la educación colaborativa o tradicional. Se entrega totalmente montada.

EN

The Vinta chair, a classic. Following the values of concept and manufacture that Grau embodies in all its creations. Sturdy and stackable. No sharp edges and designed for long use. Versatile for collaborative or traditional learning. Supplied fully assembled.

ESTRUCTURA METÁLICA SOLDADA / WELDED METAL FRAME (Ø20x1.5mm)  
Pintura en polvo epoxi blanco RAL9010 microtexturado / Microtexture white epoxy powder coating RAL9010

## COLORES / COLOURS



TURQUESA  
TURQUOISE



MOSTAZA  
MUSTARD



MADERA NÓRDICA  
NORDIC WOOD

## \* MEDIDAS / MEASUREMENTS

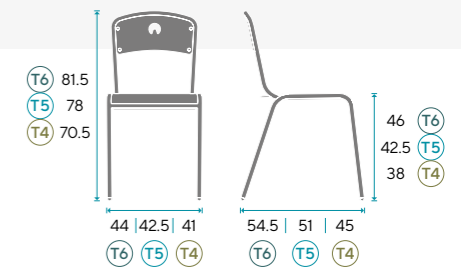

## VERSIONES / VERSIONS

## Kiddy Vinta



APILABLE  
STACKABLE

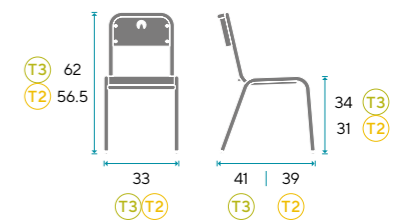

\* Todas las medidas son en centímetros / All measurements are in centimetres

# Cosy

APILABLE  
STACKABLE



COLORES / COLOURS



TURQUESA  
TURQUOISE



MOSTAZA  
MUSTARD

\* MEDIDAS / MEASUREMENTS

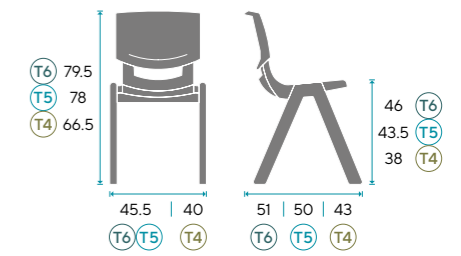

VERSIONES / VERSIONS

## Kiddy Cosy



APILABLE  
STACKABLE

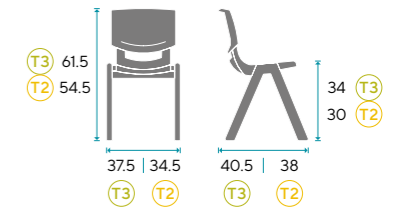

\* Todas las medidas son en centímetros / All measurements are in centimetres

ES

La silla Cosy, práctica. Siguiendo la línea de colores que Grau impregna en todas sus creaciones. Monobloque, ligera y apilable. Uso para interior o exterior. Versátil para comedores y para la educación colaborativa o tradicional.

EN

The Cosy chair, practical. Following the colours range that Grau embodies in all its creations. Single-piece, light and stackable. For indoor or outdoor use. Versatile for dining halls and collaborative or traditional learning.

## Woody



ES

La silla Woody, elegancia atemporal. Siguiendo los valores de concepción y fabricación que Grau impregna en todas sus creaciones. Robusta y apilable. Sin aristas vivas y diseñada para un uso prolongado. Versátil para bibliotecas y para la educación colaborativa o tradicional. Se entrega totalmente montada.

EN

The Woody chair, timeless elegance. Following the values of concept and manufacture that Grau embodies in all its creations. Sturdy and stackable. No sharp edges and designed for long use. Versatile for libraries and collaborative or traditional learning. Supplied fully assembled.



ESTRUCTURA METÁLICA SOLDADA / WELDED METAL FRAME (Ø20x1.5mm)  
Pintura en polvo epoxi blanco RAL9010 microtexturado / Microtexture white epoxy powder coating RAL9010

APILABLE  
STACKABLEGANCHO  
HOOK

\* MEDIDAS / MEASUREMENTS

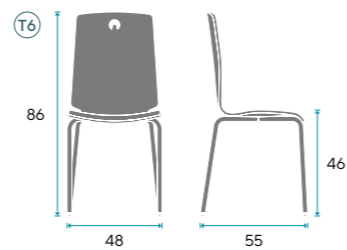

\* Todas las medidas son en centímetros / All measurements are in centimetres

## Pivot



ES

El taburete Pivot, ergonomía dinámica de 360°. Siguiendo los valores de concepción y fabricación que Grau impregna en todas sus creaciones. Robusto y pivotante, con asiento de madera maciza. Sin aristas vivas y diseñado para un uso prolongado. Idóneo para la educación colaborativa. Se entrega totalmente montado.

EN

The Pivot stool, 360° dynamic ergonomics. Following the values of concept and manufacture that Grau embodies in all its creations. Sturdy and tilting, with a seat made in solid wood. No sharp edges and designed for long use. Ideal for collaborative learning. Supplied fully assembled.

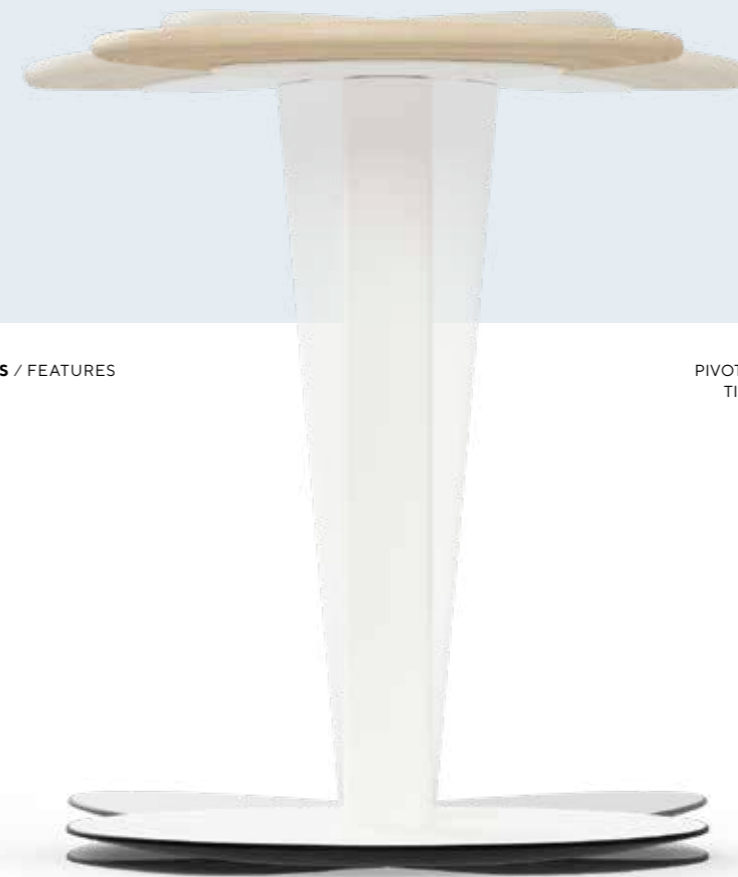

CARACTERÍSTICAS / FEATURES

PIVOTANTE  
TILTING

\* MEDIDAS / MEASUREMENTS

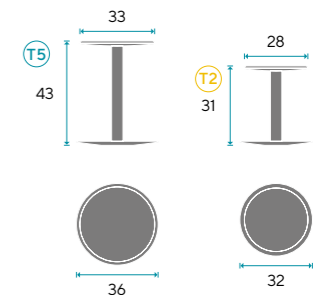

\* Todas las medidas son en centímetros / All measurements are in centimetres

# Productos *Products*



Almacenaje — *Storage*



# Dot 82



ES

Los armarios Dot 82, un toque de personalidad. Siguiendo los valores de concepción y fabricación que Grau impregna en todas sus creaciones. Minimalistas, robustos y con acabados neutros nórdicos, en que los colores los aporta el material escolar. Armarios bajos para almacenaje con estantes, cartulíneros o bandejas. Puertas de CDF sin aristas vivas. Diseñados para un uso prolongado. Versátiles para la educación colaborativa o tradicional. Se entregan totalmente montados.

EN

The Dot 82 cupboards, a touch of character. Following the values of concept and manufacture that Grau embodies in all its creations. Minimalist, sturdy and with neutral Scandinavian finishes with colour carried by the school stuff. Low cupboards for storage on shelves and wide card shelves or in trays. CDF doors without sharp edges. Designed for long use. Versatile for collaborative or traditional learning. Supplied fully assembled.

ACABADOS / FINISHES

GRAFITO  
GRAPHITE

TURQUESA  
TURQUOISE



OLIVA  
OLIVE

MOSTAZA  
MUSTARD



ACCESORIOS / ACCESSORIES

BANDEJAS  
TRAYS



GRANDE / LARGE  
ÚTILES / EFFECTIVE 15 x 32 x 25.5  
PEQUEÑA / SMALL  
ÚTILES / EFFECTIVE 7 x 33 x 27



CERRADURA  
LOCK



CARACTERÍSTICAS / FEATURES

NIVELADOR  
HEIGHT-  
ADJUSTABLE  
FOOT



Dot 82 E



Dot 82 P



Dot 82 A



Dot 82 B



Dot 82 C



Dot 82 F



MEDIDAS / MEASUREMENTS\*

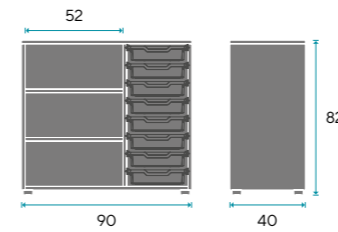
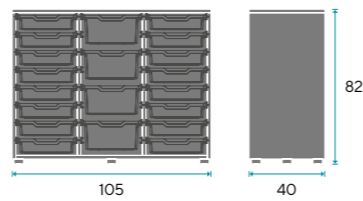
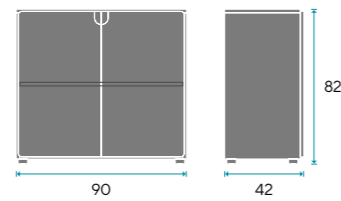
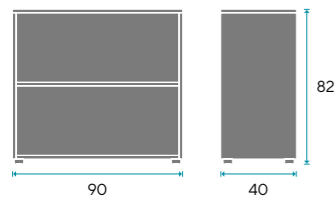

\* Todas las medidas son en centímetros / All measurements are in centimetres

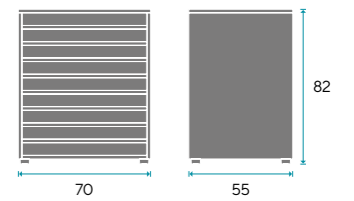
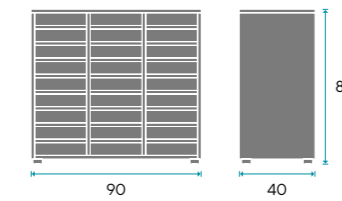



# Dot 159



ES

Los armarios Dot 159, un toque de personalidad. Siguiendo los valores de concepción y fabricación que Grau impregna en todas sus creaciones. Minimalistas, robustos y con acabados neutros nórdicos, en que los colores los aporta el material escolar. Armarios medianos para almacenaje con estantes, casilleros o bandejas. Puertas de CDF altas y bajas sin aristas vivas. Diseñados para un uso prolongado. Versátiles para la educación colaborativa o tradicional. Se entregan totalmente montados.

EN

The Dot 159 cupboards, a touch of character. Following the values of concept and manufacture that Grau embodies in all its creations. Minimalist, sturdy and in neutral Nordic finishes where colour is carried by the school stuff. Medium sized cupboards for storage on shelves or in boxes and trays. Tall and low-height CDF doors without sharp edges. Designed for long use. Versatile for collaborative or traditional learning. Supplied fully assembled.

ACABADOS / FINISHES

GRAFITO  
GRAPHITE

TURQUESA  
TURQUOISE



OLIVA  
OLIVE

MOSTAZA  
MUSTARD



ACCESORIOS / ACCESSORIES

BANDEJAS  
TRAYS



GRANDE / LARGE  
ÚTILES / EFFECTIVE 15 x 32 x 25.5  
PEQUEÑA / SMALL  
ÚTILES / EFFECTIVE 7 x 33 x 27



CERRADURA  
LOCK



CARACTERÍSTICAS / FEATURES

NIVELADOR  
HEIGHT-  
ADJUSTABLE  
FOOT



Dot 159 E



Dot 159 M



Dot 159 P



Dot 159 A



Dot 159 C



MEDIDAS / MEASUREMENTS\*

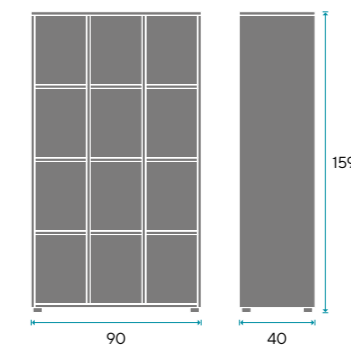
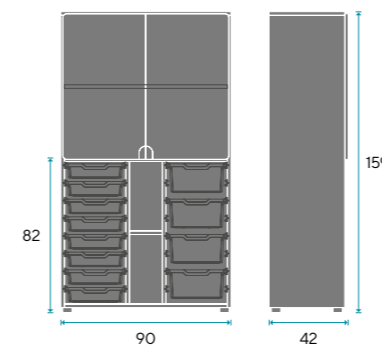
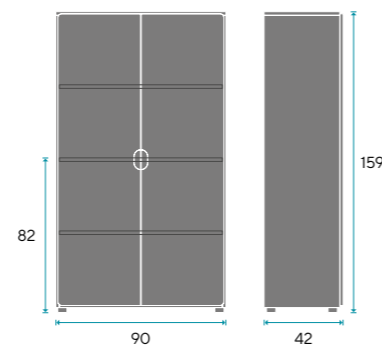
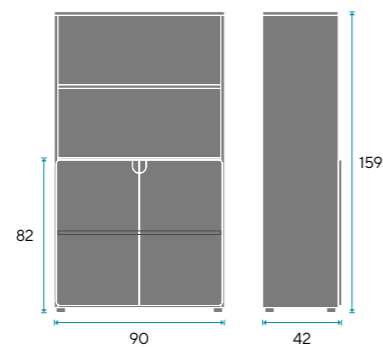
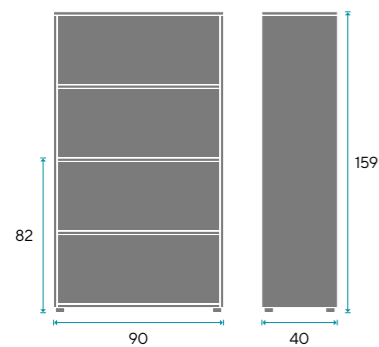

\* Todas las medidas son en centímetros / All measurements are in centimetres

# Dot 197



ES

Los armarios Dot 197, un toque de personalidad. Siguiendo los valores de concepción y fabricación que Grau impregna en todas sus creaciones. Minimalistas, robustos y con acabados neutros nórdicos, en que los colores los aporta el material escolar. Armarios altos para almacenaje con estantes, expositores, vitrinas o taquillas. Puertas de CDF altas y bajas sin aristas vivas. Diseñados para un uso prolongado. Versátiles para la educación colaborativa o tradicional. Se entregan totalmente montados.

EN

The Dot 197 cupboards, a touch of character. Following the values of concept and manufacture that Grau embodies in all its creations. Minimalist, sturdy and in neutral Nordic finishes where colour is carried by the school stuff. Tall cupboards for storage on shelves, with display cabinets, trays or lockers. Tall and low-height CDF doors without sharp edges. Designed for long use. Versatile for collaborative or traditional learning. Supplied fully assembled.

ACABADOS / FINISHES



ACCESORIOS / ACCESSORIES



CARACTERÍSTICAS / FEATURES

NIVELADOR HEIGHT-ADJUSTABLE FOOT



Dot 197 E



Dot 197 M



Dot 197 V



Dot 197 P



Dot 197 R



Dot 197 T



MEDIDAS / MEASUREMENTS \*

\* Todas las medidas son en centímetros / All measurements are in centimetres

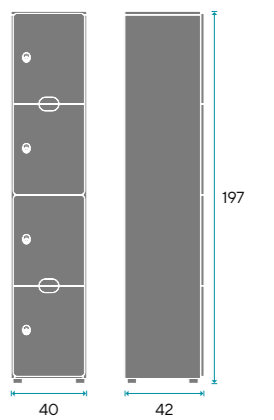
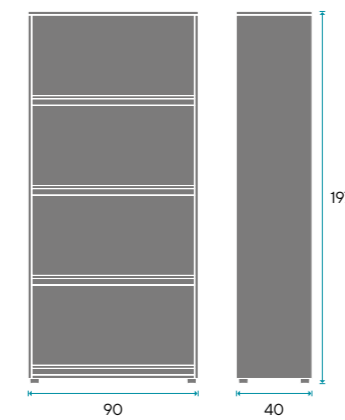
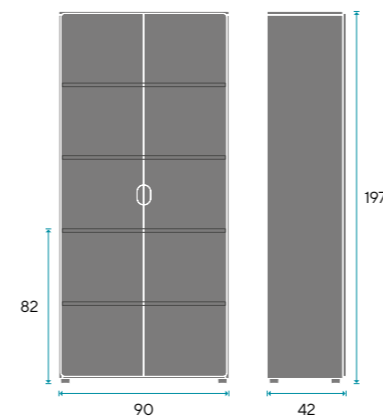
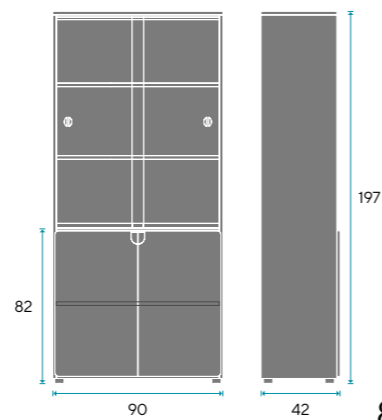
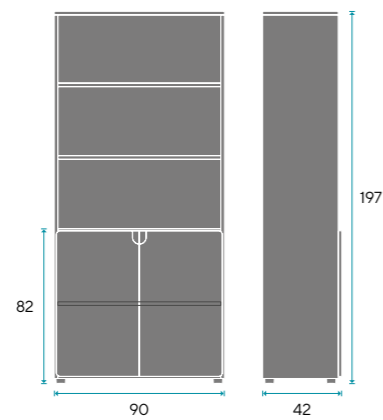
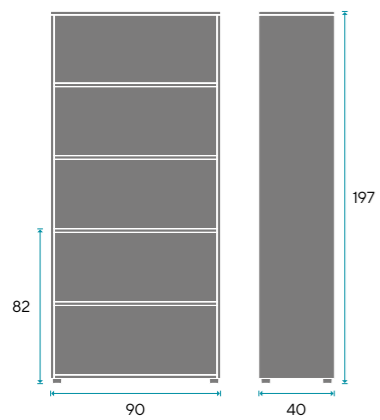

# Agora



ES

La grada Agora, ¿debatimos? Siguiendo los valores de concepción y fabricación que Grau impregna en todas sus creaciones. Minimalista y robusta. Superficie de fenólico y puertas de CDF sin aristas vivas y diseñada para un uso prolongado. Idónea para la educación colaborativa. Se entrega totalmente montada.

EN

Agora seating, shall we talk about it? Following the values of concept and manufacture that Grau embodies in all its creations. Minimalist and sturdy. Phenolic surface and CDF doors without sharp edges and designed for long use. Ideal for collaborative learning. Supplied fully assembled.

GRAFITO  
GRAPHITE



TURQUESA  
TURQUOISE



OLIVA  
OLIVE



MOSTAZA  
MUSTARD



\* Tiradores puertas / Door handles

NIVELADOR  
HEIGHT-  
ADJUSTABLE  
FOOT



VERSIONES / VERSIONS

Agora C



Agora One



MEDIDAS / MEASUREMENTS \*

\* Todas las medidas son en centímetros / All measurements are in centimetres

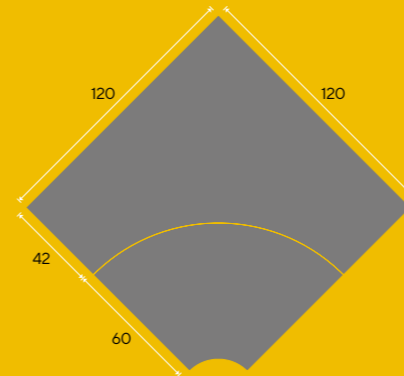
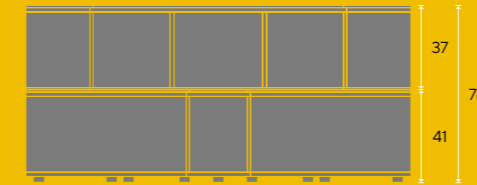
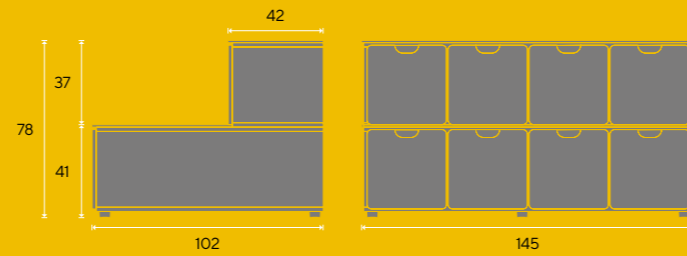

# Cadi

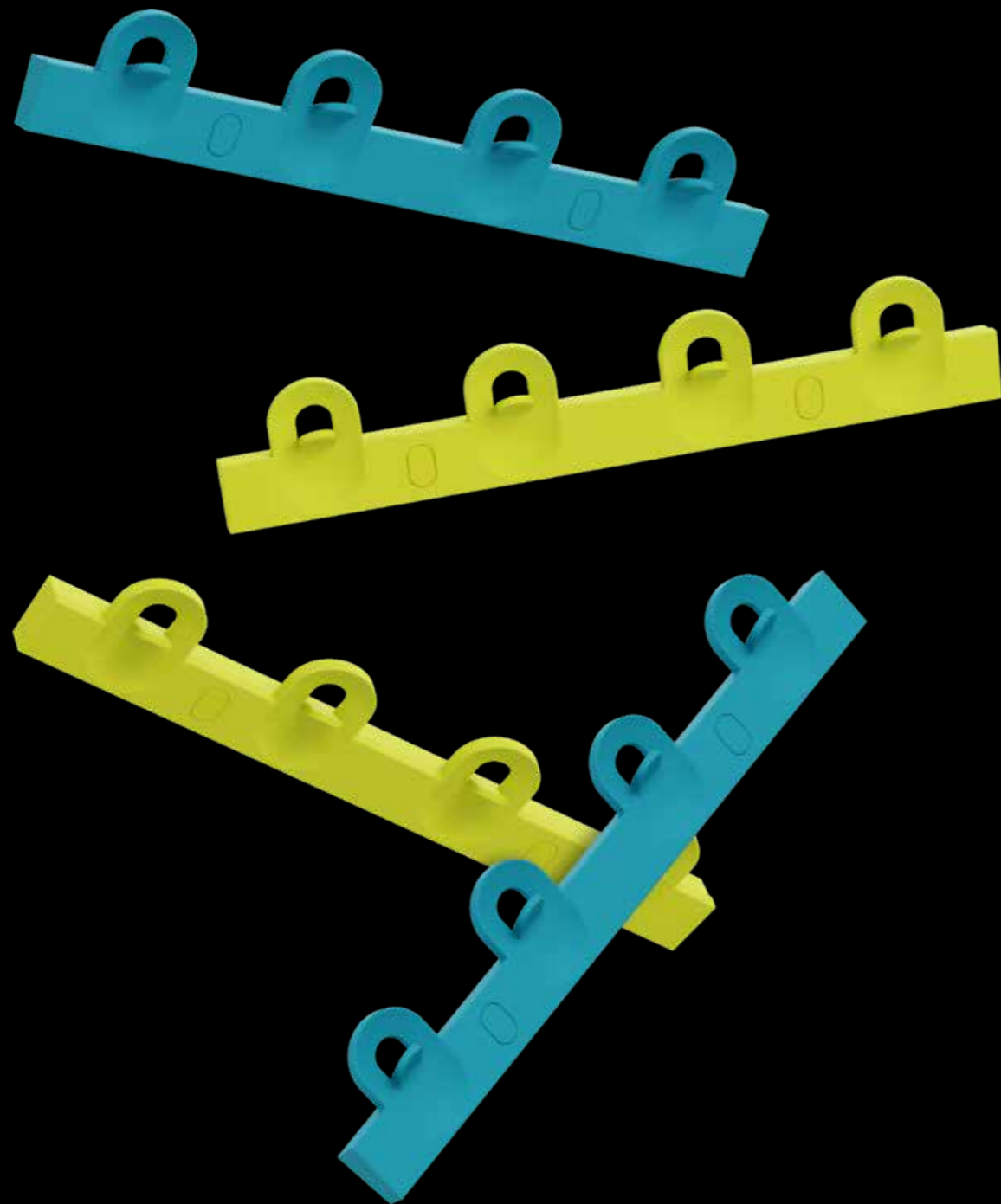
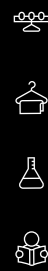

GRAFITO  
GRAPHITE

TURQUESA  
TURQUOISE

OLIVA  
OLIVE

MOSTAZA  
MUSTARD

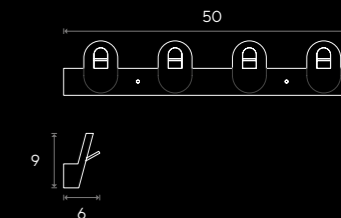

\* Todas las medidas son en centímetros / All measurements are in centimetres

## Cadi Plus

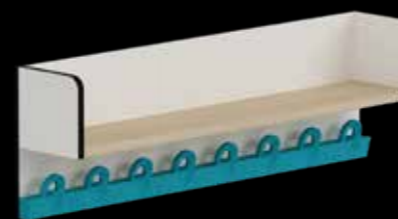

Percha Cadi doble con estante superior portaobjetos. / Cadi coat hooks with shelf above.

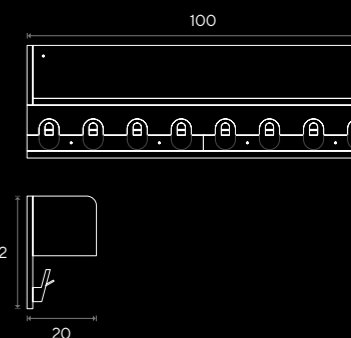

### ACOPLAMIENTO CADI LINKING CADI

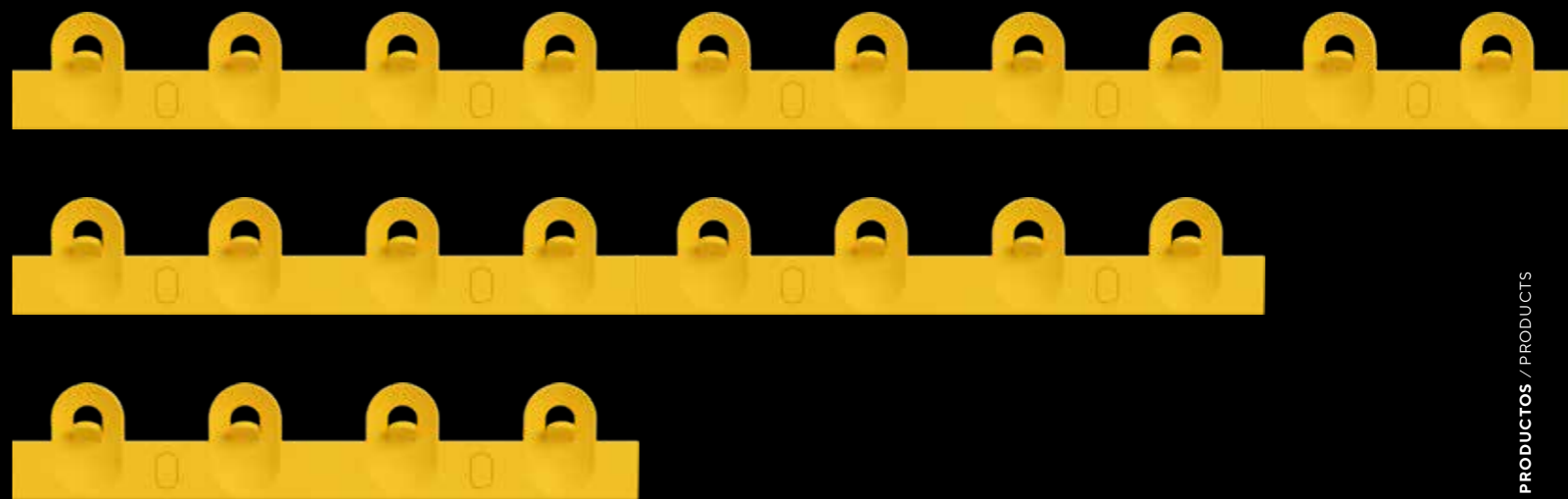

### ACOPLAMIENTO CADI PLUS LINKING CADI PLUS



ES

La percha Cadi, orden con estilo propio. Siguiendo los valores de concepción y fabricación que Grau impregna en todas sus creaciones. Colores armónicos. Dobles ganchos sin aristas vivas y diseñada para un uso prolongado. Versátil para la educación colaborativa o tradicional. Se entrega totalmente montada.

EN

Cadi coat hooks, order with its own style. Following the values of concept and manufacture that Grau embodies in all its creations. Harmonious colours. Double hooks with no sharp edges and designed for long use. Versatile for collaborative or traditional learning. Supplied fully assembled.

DOS GANCHOS  
EN UNO  
TWO HOOKS IN  
ONE



# Productos *Products*

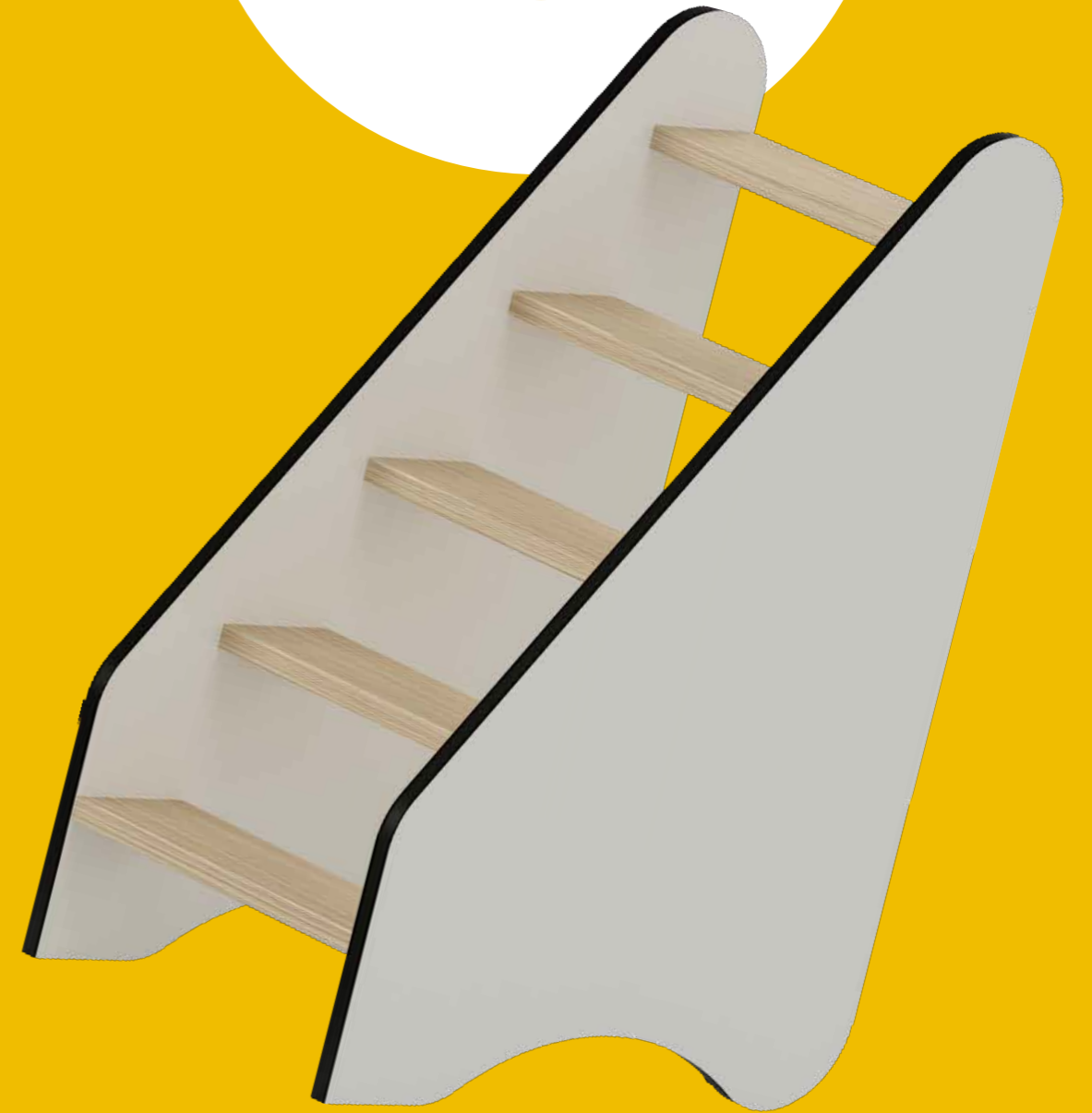

Infantil — *Infants*



# Kiddy R & G

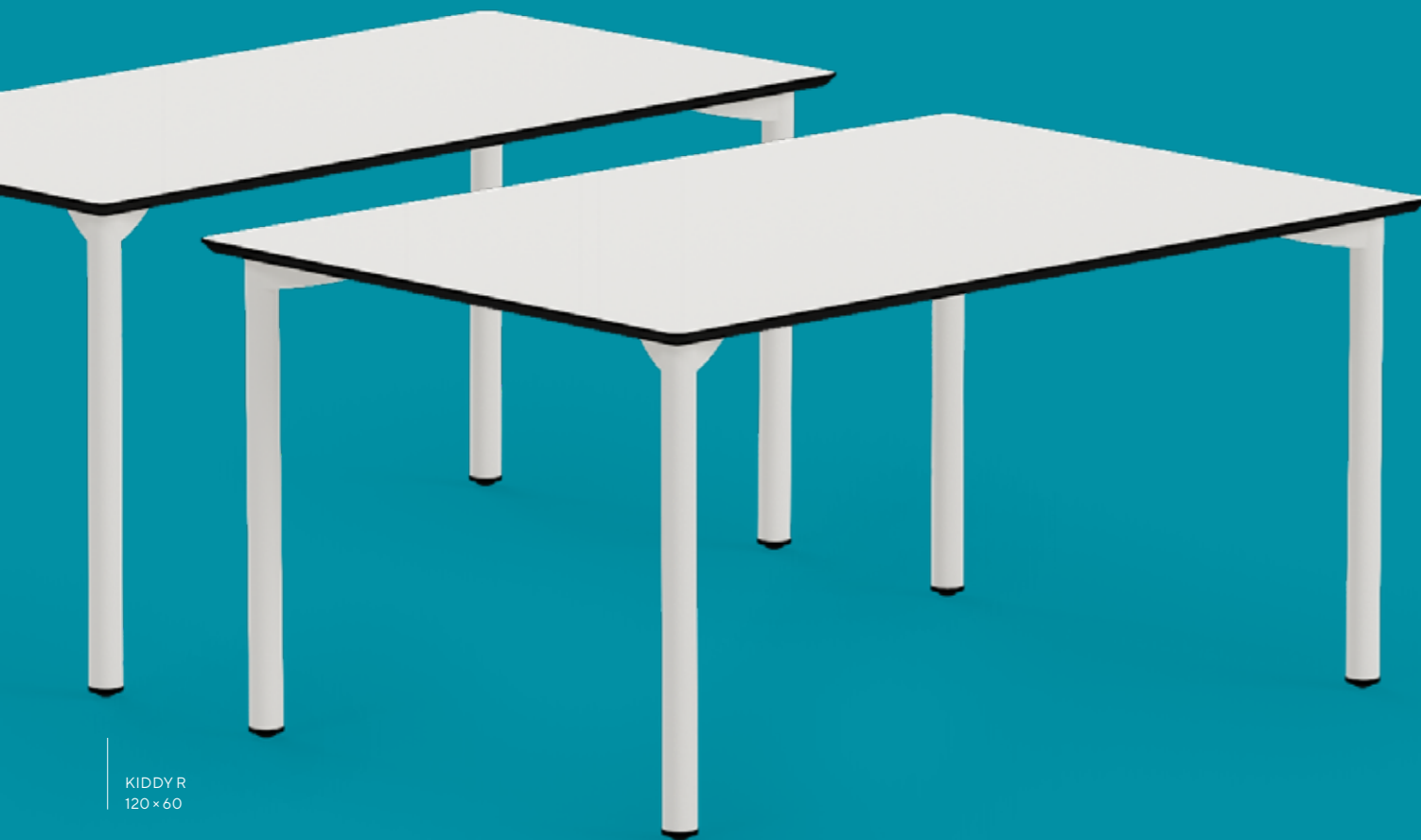

KIDDY R  
120 x 60

KIDDY G  
120 x 80

ES

Mesas Kiddy, creando pequeños grandes proyectos. Siguiendo los valores de concepción y fabricación que Grau impregna en todas sus creaciones. Minimalistas y robustas con distintas formas. Sin aristas vivas y diseñadas para un uso prolongado. Idóneas para la educación infantil colaborativa. Se entregan totalmente montadas.

EN

Kiddy tables, creating little big projects. Following the values of concept and manufacture that Grau embodies in all its creations. Minimalist and sturdy and in different shapes. No sharp edges and designed for long use. Ideal for collaborative learning in infants. Supplied fully assembled.

ACABADOS / FINISHES



CDF BLANCO / WHITE CDF (16.4mm)  
Fibras de densidad compacta / Compact density fibres



PATAS CON PLETINAS METÁLICAS SOLDADAS / LEGS WITH WELDED METAL PLATES (Ø40x1.5mm)  
Pintura en pols epoxi blanc RAL9010 microtexturat / Microtexture white epoxy powder coating RAL9010

\* MEDIDAS / MEASUREMENTS

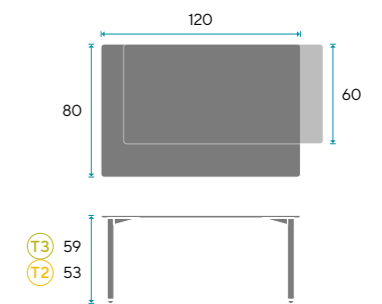

VERSIONES / VERSIONS

## Kiddy T

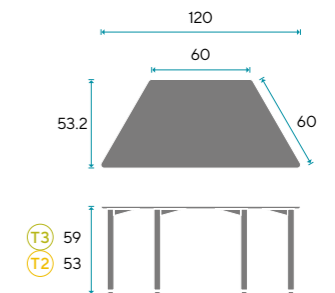

## Kiddy C

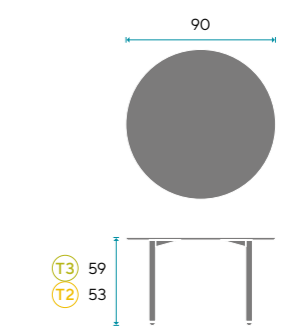

## Kiddy E

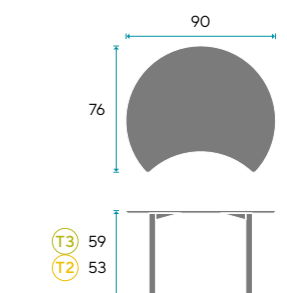

## Kiddy SC

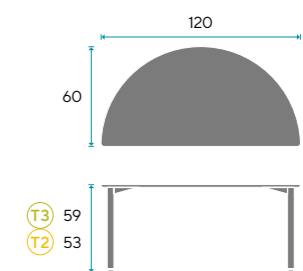

\* Todas las medidas son en centímetros / All measurements are in centimetres

# Kiddy M



ES

Mesa Kiddy M, no resta espacio. Siguiendo los valores de concepción y fabricación que Grau impregna en todas sus creaciones. Minimalista y plegable contra la pared. Sin aristas vivas y diseñada para un uso prolongado. Idónea para la educación colaborativa y para el comedor. Se entrega totalmente montada.

EN

The Kiddy M table, it doesn't take up any space. Following the values of concept and manufacture that Grau embodies in all its creations. Minimalist and can be folded against the wall. No sharp edges and designed for long use. Ideal for collaborative learning and in the dining hall. Supplied fully assembled.



ACABADOS / FINISHES



CDF BLANCO / WHITE CDF (16.4mm)  
Fibras de densidad compacta / Compact density fibres

CARACTERÍSTICAS / FEATURES

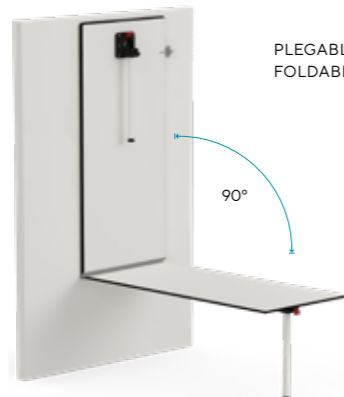

PLEGABLE FOLDABLE

90°

\* MEDIDAS / MEASUREMENTS

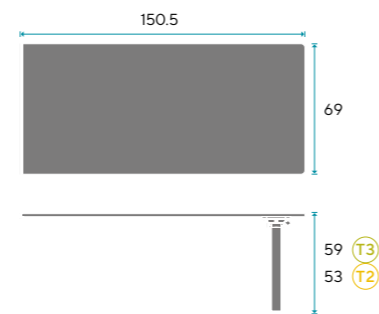

\* Todas las medidas son en centímetros / All measurements are in centimetres

KIDDY R & G

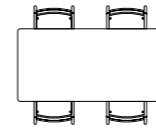

KIDDY T

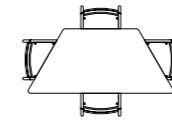

KIDDY E

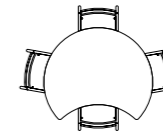

KIDDY SC

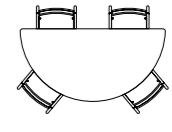

6

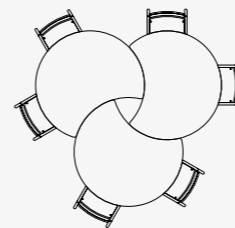
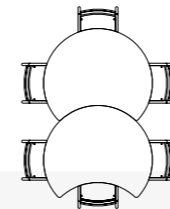
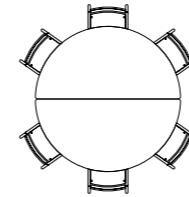
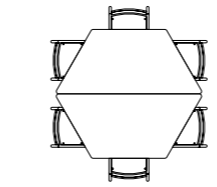

7

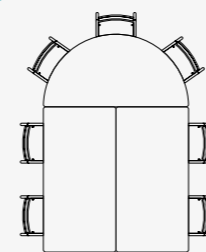

8

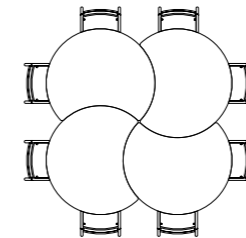
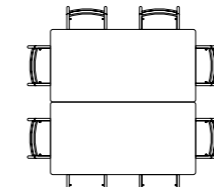

9

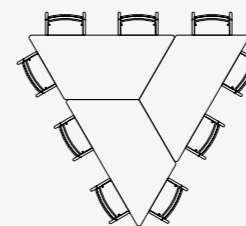
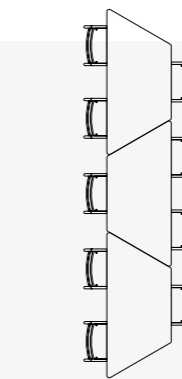

10

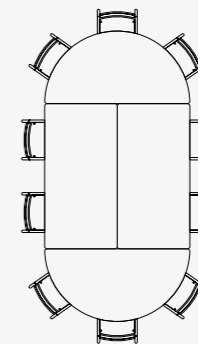
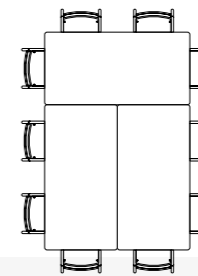
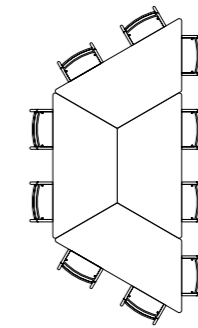

12

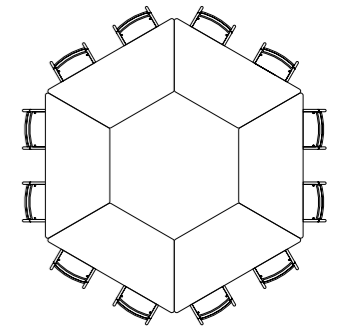

16

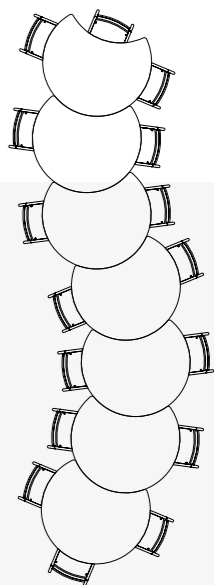

19

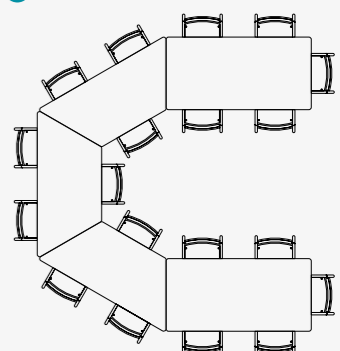

COMBINABLE CON / COMBINABLE WITH KIDDY R & G KIDDY T KIDDY E KIDDY SC

# Kiddy 45, 59, 95 & Step



ES

Complementos Kiddy, siempre útiles. Siguiendo los valores de concepción y fabricación que Grau impregna en todas sus creaciones. Minimalistas, robustos y con acabados neutros nórdicos, en que los colores los aporta el material escolar. Casillero mural, cambiador, escalera y carro con ruedas. Diseñados para un uso prolongado. Se entregan totalmente montados.

EN

Totally Kiddy, always useful. Following the values of concept and manufacture that Grau embodies in all its creations. Minimalist, sturdy and in neutral nordic finishes where colour is carried by the school stuff. Wall pigeonhole unit, changing station and wheeled storage unit. Designed for long use. Supplied fully assembled.

Kiddy 45



Kiddy 59



Kiddy 95



Kiddy Step



MEDIDAS / MEASUREMENTS\*

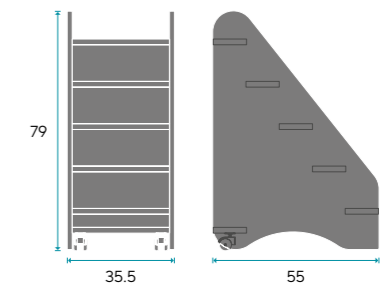
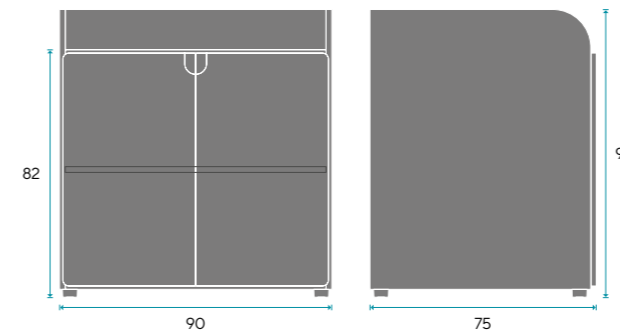
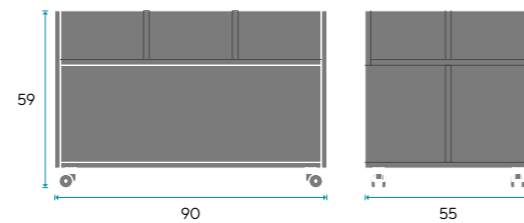
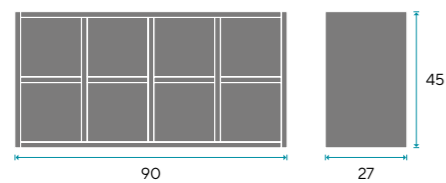

\*Todas las medidas son en centímetros / All measurements are in centimetres

ACABADOS / FINISHES





# Espacios *Spaces*



1

Colaborativo —  
*Collaborative*



2

Colaborativo —  
*Collaborative*

04. ESPACIOS / SPACES



3

Colaborativo —  
*Collaborative*



Un mismo espacio, diferentes  
posibilidades — *One space,  
many possibilities*

PRODUCTOS  
UTILIZADOS /  
PRODUCTS USED



SILLA / CHAIR  
SOFT  
SOFT R



PUPITRE / DESK  
ECLIPSE



MESA / TABLE  
TWIST OVAL  
DISC UP



ACCESORIOS / ACCESSORIES  
CADI  
BOX



ALMACENAJE / STORAGE  
DOT 159 P  
AGORA  
AGORAC

Colaborativo —  
Collaborative



Convencional —  
Conventional

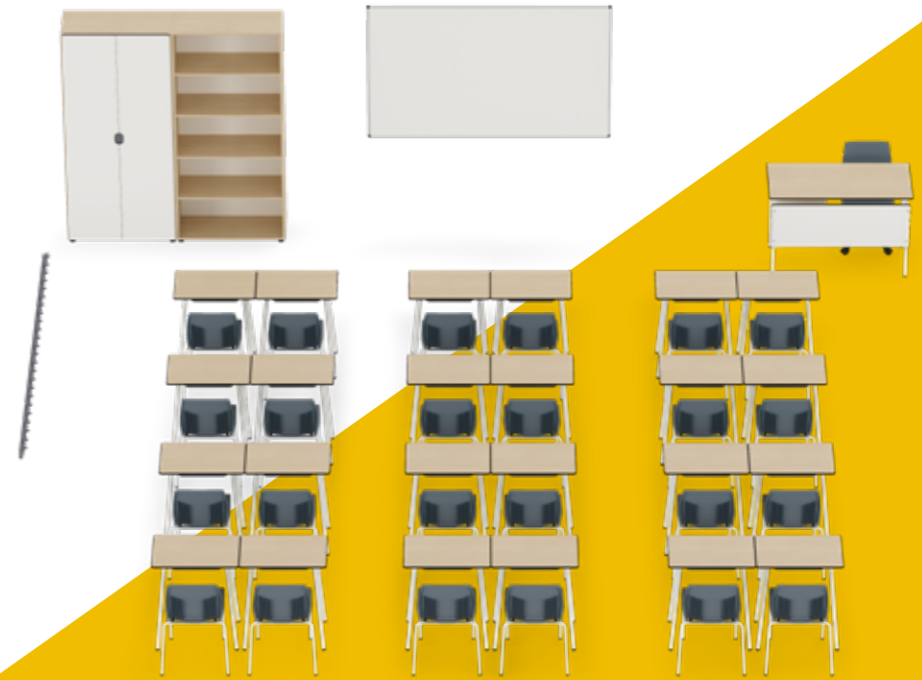

PRODUCTOS  
UTILIZADOS /  
PRODUCTS USED

SILLA / CHAIR  
SOFT R  
SLIM PROF

PUPIRE / DESK  
PETAL  
PAR  
PILE

MESA / TABLE  
DISC F

ACCESORIOS /  
ACCESSORIES  
CADI  
BOX

ALMACENAJE / STORAGE  
DOT 159 E  
DOT 159 M  
DOT 159 P  
AGORA ONE



SILLA / CHAIR  
SLIM  
SLIM PROF

PUPIRE / DESK  
DESK ONE

MESA / TABLE  
PROF

ACCESORIOS /  
ACCESSORIES  
CADI  
PIZARRA /  
WHITEBOARD

ALMACENAJE / STORAGE  
DOT 197 P  
DOT 197 E

Colaborativo —  
Collaborative

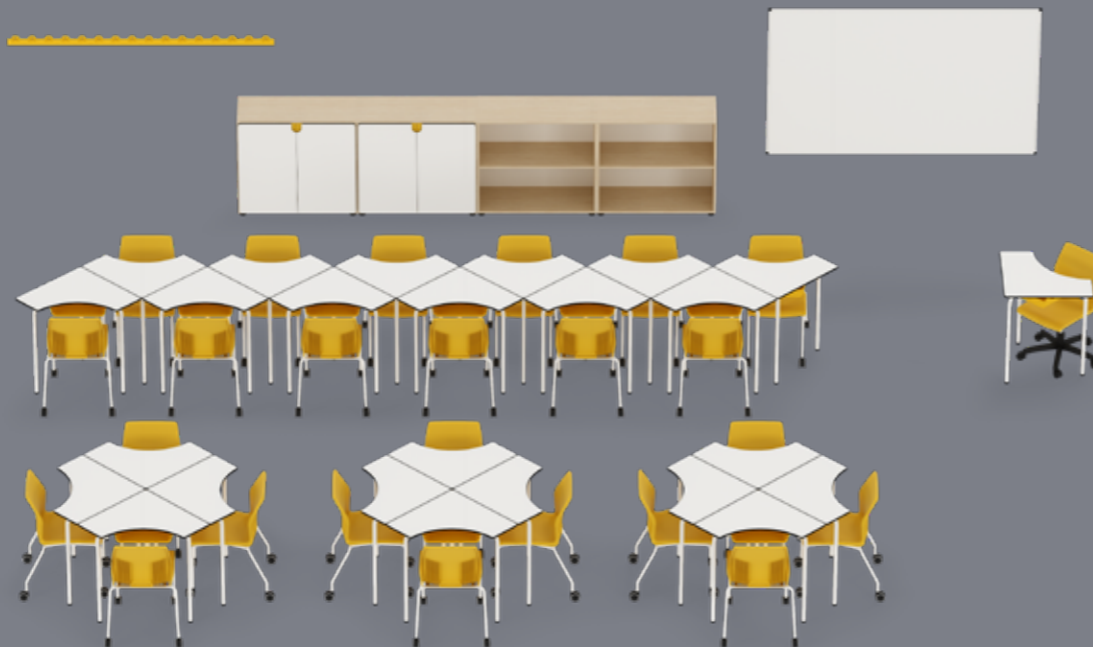

PRODUCTOS  
UTILIZADOS /  
PRODUCTS USED

SILLA / CHAIR  
SLIM R  
SLIM PROF

PUPIRE / DESK  
SHARP

ACCESORIOS /  
ACCESSORIES  
CADI  
PIZARRA /  
WHITEBOARD  
BOX

ALMACENAJE / STORAGE  
DOT 82 E  
DOT 82 P

1

Infantil —  
For infants



SILLA / CHAIR  
KIDDY VINTA  
PIVOT  
SLIM PROF



MESA / TABLE  
KIDDY 5C  
KIDDY R  
PROF



ACCESORIOS /  
ACCESSORIES  
CADI PLUS  
KIDDY 59



ALMACENAJE / STORAGE  
DOT 82 A  
DOT 82 P

PRODUCTOS  
UTILIZADOS /  
PRODUCTS USED

Biblioteca —  
Library



SILLA / CHAIR  
WOODY  
PIVOT



MESA / TABLE  
LINE 150  
DISC F



ACCESORIOS /  
ACCESSORIES  
CADI  
KIDDY 59



ALMACENAJE / STORAGE  
DOT 197 E  
DOT 197 R  
AGORA  
AGORA C  
AGORA ONE

PRODUCTOS  
UTILIZADOS /  
PRODUCTS USED

2

Infantil —  
For infants

04. ESPACIOS / SPACES



SILLA / CHAIR  
KIDDY COSY  
SLIM PROF



MESA / TABLE  
TWIST OVAL  
DISC UP  
KIDDY E



ACCESORIOS /  
ACCESSORIES  
PIZARRA /  
WHITEBOARD



ALMACENAJE / STORAGE  
DOT 82 A  
DOT 197 M  
DOT 197 P  
AGORA ONE

Universidad —  
University

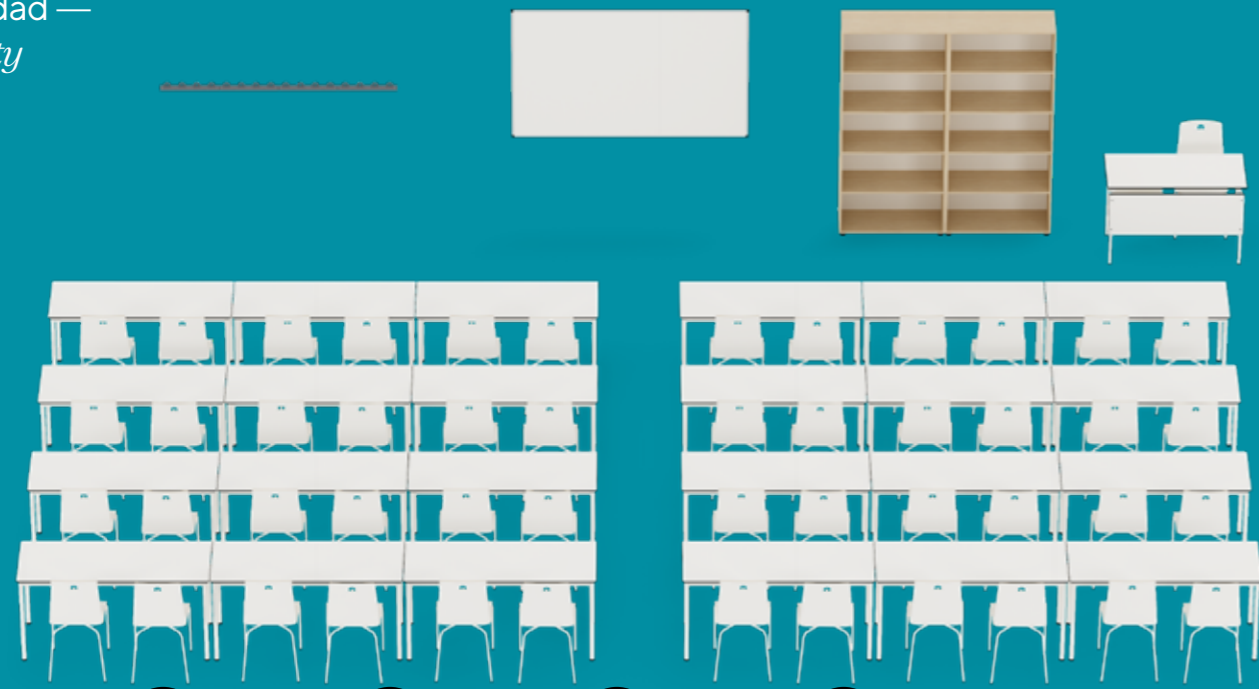

SILLA / CHAIR  
**WOODY**



MESA / TABLE  
**PROF LINE 150**



ACCESORIOS /  
ACCESSORIES  
**CADI  
PIZARRA /  
WHITEBOARD**



ALMACENAJE / STORAGE  
**DOT 197 E**

PRODUCTOS  
UTILIZADOS /  
PRODUCTS USED

Comedor —  
Dining hall

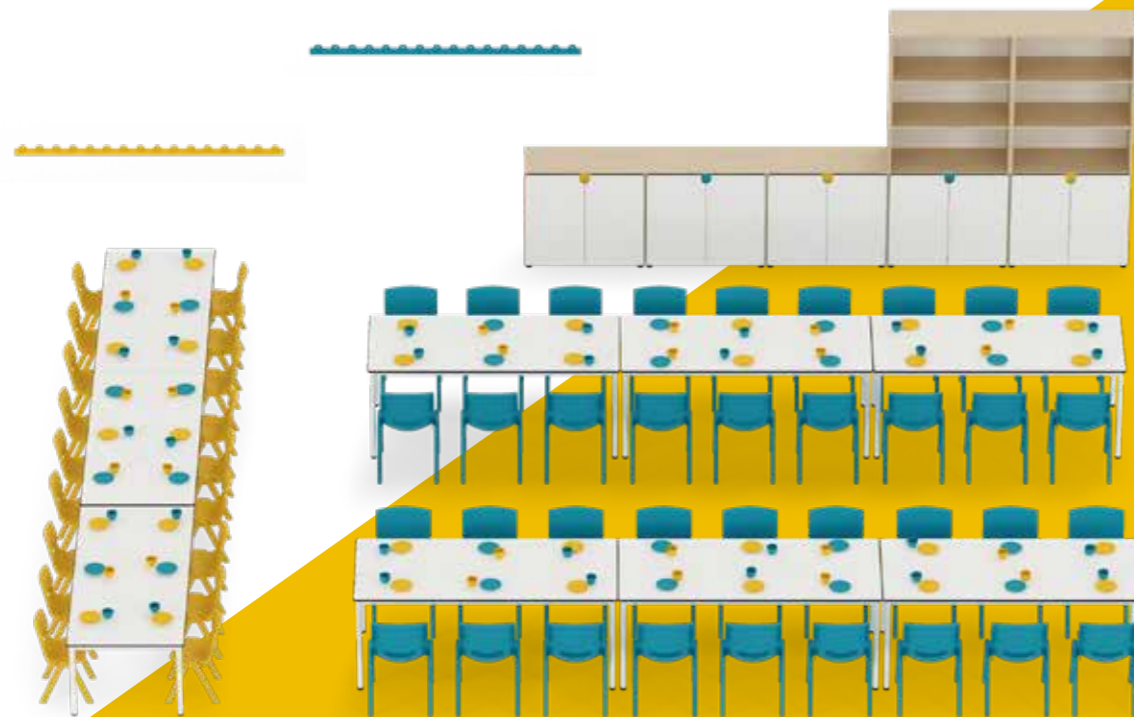

SILLA / CHAIR  
**KIDDY COSY  
COSY**



MESA / TABLE  
**LINE 120 T3  
LINE 180 T6**



ACCESORIOS /  
ACCESSORIES  
**CADI**



ALMACENAJE / STORAGE  
**DOT 82 P  
DOT 197 M**

PRODUCTOS  
UTILIZADOS /  
PRODUCTS USED

Lab & Tech —  
Lab & Tech

04. ESPACIOS / SPACES



SILLA / CHAIR  
**SLIM F  
SLIM G**



MESA / TABLE  
**LINE 180  
DISC UP**



ACCESORIOS /  
ACCESSORIES  
**CADI**



ALMACENAJE / STORAGE  
**DOT 197 V  
DOT 82 A**

Recepción —  
Reception hall



SILLA / CHAIR  
**SLIM B**



ACCESORIOS /  
ACCESSORIES  
**CADI**



TAQUILLAS / LOCKERS  
**DOT 197 T**



# General *General*

Técnico y Overview — *Specifications  
and Overview*

# Técnico — Specifications

## Tallas y medidas — Sizes and measurements



ES

Todas las tallas y medidas son relativas a las dimensiones funcionales de las sillas y mesas para centros de enseñanza, según la normativa ISO 5970 o UNE-EN 1729-1 (con una tolerancia admisible de  $\pm 1$  cm).

EN

All sizes and measurements are relative to the functional dimensions of chairs and tables for educational establishments in accordance with ISO 5970 or UNE-1729-1 (with an allowed tolerance of  $\pm 1$  cm).

TALLA SIZE	EDAD AGE	CURSO SCHOOL STAGE	ALT. ASIENTO H. CHAIR	ALT. MESA H. TABLE
<b>T8*</b>	+11	SECUNDARIA O SUPERIOR SECONDARY OR ABOVE	65 cm	90 cm
<b>T6</b>	+11	SECUNDARIA O SUPERIOR SECONDARY OR ABOVE	46 cm	76 cm
<b>T5</b>	8–11	PRIMARIA JUNIOR	43 cm	71 cm
<b>T4</b>	6–8	PRIMARIA JUNIOR	38 cm	64 cm
<b>T3</b>	5–6	INFANTIL INFANTS	35 cm	59 cm
<b>T2</b>	3–5	INFANTIL INFANTS	31 cm	53 cm

\* Equivalencia para mesas de trabajo de pie / Equivalent for standing work tables

## Iconografía — Iconography

### CATEGORÍA / CATEGORY

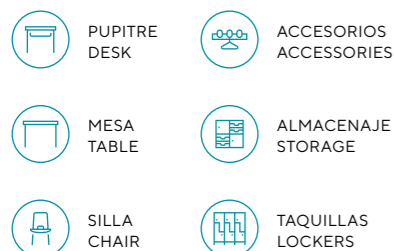

### ESCUELA / SCHOOL

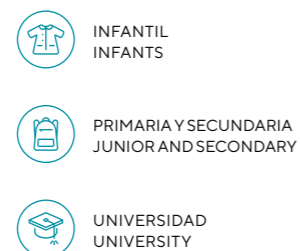

### ÁREAS / AREAS



## 05. TÉCNICO / SPECIFICATIONS

## Materiales — Materials

### Fenólico — PF Resin

**ES** Panel indivisible, formado por múltiples láminas kraft impregnadas con resina fenólica. Resistencia al rayado y al calor, hidrófugo y fácil de limpiar, resistencia a los productos químicos y alta resistencia a los impactos y a la creación de grietas.

**EN** Single panel formed of several layers of kraft impregnated with polyphenolic resin. Scratch and heat-resistant; impervious to water and easy to clean, resistant to chemicals and high impact and fissure resistance.

ESPESOR / THICKNESS 12 mm  
DENSIDAD / DENSITY 1410 Kg/m<sup>3</sup>

### CDF — CDF

Panel indivisible, formado por fibras de densidad compacta. Fácil de limpiar, buena resistencia a la humedad y alta resistencia a los impactos y a la creación de grietas.

Single panel formed of compact density fibre. Easy to clean, good damp resistance and high impact and fissure resistance.

ESPESOR / THICKNESS 16.4 mm  
DENSIDAD / DENSITY 1000 Kg/m<sup>3</sup>

### Melamina — Melamine

Panel de aglomerado con acabado melamínico a dos caras. Opcional: melamina rotulable con acabado liso brillante.

Aglomerate wood with melamine on both sides. Optional: writeable melamine with smooth brilliant finish.

ESPESOR / THICKNESS 19 mm  
DENSIDAD / DENSITY 680 Kg/m<sup>3</sup>  
CANTEADO PVC RÍGIDO / RIGID PVC EDGING 1.2 mm

### Estructuras — Structures

**ES** Fabricadas con tubo de acero laminado en frío, de grosor desde 1.5 mm a 3 mm según modelo. Estructuras soldadas.

**EN** Made from cold-laminated steel tubing of thicknesses 1.5 mm - 3 mm depending on product. Welded structures.

### Asientos y respaldos — Seats and chair backs (Vinta + Woody)

Tablero contrachapado con láminas de madera de haya. Lámina exterior de Laminado de Alta Presión (HPL), encolado con alta frecuencia.

Panel in beech ply. Surface in High Pressure Laminate (HPL) with high frequency gluing.

### Plástico — Plastic

Polipropileno reforzado (PP).

Reinforced polypropylene (PP).

### Pintura — Paint

**ES** Todas las estructuras de hierro están pintadas con polvo tipo Epoxi-Poliéster, color blanco RAL9010 microtexturizado, mediante túnel automatizado: desengrase, fosfatado, lavado, pasivado, secado, recubrimiento en polvo electrostático y polimerización final para garantizar una máxima adhesión y durabilidad de la pintura.

**EN** All steel structures are finished with microtextured RAL9010 white Epoxy-Polyester powder coating in an automated powder coating tunnel: degreased, phosphate-washed, washed, passivated, dried, final coat of polymerised electrostatic powder to ensure maximum adhesion and durability of the finish.

# Overview

Pupitres — Desks



Desk One — p.34



Desk Two — p.35



Eclipse — p.36



Petal — p.38



End — p.40



Par — p.42



Sharp — p.44



Pile — p.46



Box — p.48

Mesas — Tables



Twist Oval — p.52



Twist R — p.53



Disc Up — p.54



Line — p.56



Disc F — p.58



Prof — p.58



Duo — p.58



Pizarra / Whiteboard — p.59

Sillas — Chairs



Soft — p.62



Soft R — p.63



Soft F — p.63



Slim — p.64



Slim R — p.65



Slim Up — p.65



Slim P — p.65



Slim F — p.66



Slim G — p.67



Slim Prof — p.67



Slim B — p.67



Vinta — p.68



Kiddy Vinta — p.69



Cosy — p.70



Kiddy Cosy — p.71



Woody — p.72



Pivot — p.73





Dot 82 E — p.76



Dot 82 P — p.76



Dot 82 A — p.76



Dot 82 B — p.77



Dot 82 C — p.77



Dot 82 F — p.77



Dot 159 E — p.78



Dot 159 M — p.78



Dot 159 P — p.78



Dot 159 A — p.79



Dot 159 C — p.79



Dot 197 E — p.80



Dot 197 M — p.80



Dot 197 V — p.80



Dot 197 P — p.81



Dot 197 R — p.81



Dot 197 T — p.81



Agora — p.82



Agora C — p.83



Agora One — p.83



Cadi — p.84



Cadi Plus — p.85



Bandejas / Trays — p.77



Kiddy R — p.88



Kiddy G — p.88



Kiddy T — p.89



Kiddy C — p.89



Kiddy E — p.89



Kiddy SC — p.89



Kiddy M — p.90



Kiddy 45 — p.92



Kiddy 59 — p.92



Kiddy 95 — p.93



Kiddy Step — p.93

EDITA / PUBLISHED BY

**Mobles Grau S.A.**  
C. Indústria 15  
Santa Eugènia de Berga (08507)  
Barcelona

T +34 938 853 918  
info@grauspace.com

CRÉDITOS / CREDITS

DIRECCIÓN DE ARTE Y DISEÑO GRÁFICO  
ART DIRECTION AND GRAPHIC DESIGN

**Suki Design Studio**

RENDER Y 3D  
RENDERER AND 3D

**Hydragrafix**

FOTOGRAFÍA Y RETOQUE  
PHOTOGRAPHY AND RETOUCHING

**Ivan Raga Photographer**

DISEÑO INDUSTRIAL  
INDUSTRIAL DESIGN

**Lúcid Design Agency**

IMPRESA  
PRINTING

**Gràfiques Copysset**

MODELOS  
MODELS

**Anna, Arnau, Laia**

NOTA / NOTE

La empresa se reserva el derecho a modificar sin previo aviso cualquiera de las características y medidas detalladas en este catálogo. Los colores impresos son orientativos; para más exactitud, consultar carta de acabados. Información válida salvo error tipográfico.

Grau may change the features or detailed measurements set out in this catalogue without prior notice. The printed colours are for guidance and for greater precision you should consult the finishing card. Information correct subject errors and omissions excepted.

© MOBLES GRAU S.A., 2021

